

CATÁLOGO



## CONEXIONES NEUMÁTICAS



# BIENVENIDOS A CAMOZZI AUTOMATION

La oferta de Camozzi Automation incluye componentes, sistemas y tecnologías para el sector de la Automatización Industrial, control de Fluidos líquidos y gaseosos y aplicaciones dedicadas a la industria del transporte y la salud.



## Contacto

**Camozzi Iberica SL**  
Avda. Altos Hornos de Vizcaya,  
33, C-1  
48901 Barakaldo - Vizcaya  
España  
Tel. +34 946 558 958  
info@camozzi.es  
www.camozzi.es

## Nuestros catálogos

### Actuación neumática



- 1 Cilindros normalizados y cilindros estándar
- 2 Cilindros compactos
- 3 Cilindros en acero INOX
- 4 Cilindros guiados
- 5 Cilindros no normalizados
- 6 Cilindros rotativos
- 7 Cilindros sin vástago
- 8 Sensores
- 9 Unidades de trabajo

### Actuación eléctrica

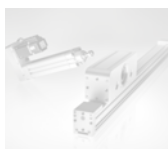

- 1 Cilindros electromecánicos
- 2 Ejes electromecánicos
- 3 Drives
- 4 Motores

### Manipulación y vacío



- 1 Pinzas
- 2 Ventosas
- 3 Eyectores
- 4 Accesorios de vacío
- 5 Filtros de vacío

### Válvulas y electroválvulas



- 1 Electroválvulas 2/2-3/2 de mando directo e indirecto
- 2 Electroválvulas, Válvulas neumáticas
- 3 Válvulas mecánicas y manuales
- 4 Válvulas lógicas
- 5 Válvulas automáticas
- 6 Válvulas de regulación de caudal
- 7 Silenciadores

### Fieldbus y sistemas multipolares



- 1 Islas de válvulas
- 2 Módulos multi-seriales

### Tecnología proporcional



- 1 Válvulas proporcionales
- 2 Reguladores proporcionales

### Tratamiento del aire

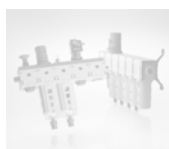

- 1 Serie MX Unidades FRL modulares
- 2 Serie MC Unidades FRL modulares
- 3 Serie MD Unidades FRL modulares
- 4 Serie N Unidades FRL
- 5 Reguladores de presión
- 6 Presostatos y vacuostatos
- 7 Accesorios para el tratamiento del aire

### Conexiones neumáticas



- 1 Racores super-rápidos
- 2 Racores rápidos
- 3 Racores universales
- 4 Racores accesorios
- 5 Enchufes rápidos
- 6 Tubos, espirales y accesorios

# Índice general

## 1 Racores super-rápidos

	Sección	Pág
 <p>Serie 6000 <b>Racores super-rápidos en latón para tubos de plástico</b></p>	<b>1.05</b>	1
 <p>Serie 7000 <b>Racores super-rápidos Compact en tecnopolímero</b></p>	<b>1.10</b>	23
 <p>Serie 8000 <b>Racores super-rápidos doble sujeción en latón</b></p>	<b>1.15</b>	36
 <p><b>Novedad</b> Serie H8000 <b>Racores super-rápidos doble sujeción en latón niquelado</b></p>	<b>1.16</b>	39
 <p>Serie X6000 <b>Racores super-rápidos en Acero Inoxidable 316L</b></p>	<b>1.25</b>	42

## 2 Racores rápidos

	Sección	Pág
 <p>Serie 1000 <b>Racores rápidos de cánula en latón para tubos de plástico</b></p>	<b>2.05</b>	49

## 3 Racores universales

	Sección	Pág
 <p>Serie 1000 <b>Racores universales de ojiva en latón</b></p>	<b>3.05</b>	62

## 4 Racores accesorios

	Sección	Pág
 <p>Serie S2000 <b>Racores accesorios Sprint® en latón</b></p>	<b>4.05</b>	68
 <p>Serie 2000 <b>Racores accesorios en latón</b></p>	<b>4.10</b>	74

## 5 Enchufes rápidos

	Sección	Pág
 <p>Serie 5000 <b>Enchufes rápidos</b></p>	<b>5.05</b>	87
 <p>Serie 5000L, 5000LT <b>Enchufes rápidos para la refrigeración de moldes de inyección de plástico</b></p>	<b>5.06</b>	93

## 6 Tubos, espirales y accesorios

	Sección	Pág
 <p>Serie T, MPL, PNZ <b>Tubos, espirales y accesorios</b></p>	<b>6.05</b>	96

## Apéndice

	Pág
Calidad: nuestro compromiso prioritario	a.01
Información para el uso de los productos Camozzi	a.02
Directiva ATEX 2014/34/EU: productos clasificados para su utilización en ambientes potencialmente explosivos	a.03
Camozzi en el mundo	a.05
Distribuidores Camozzi en el mundo	a.06

# Índice alfanumérico

Modelo	Serie	Sección	Pág	Modelo	Serie	Sección	Pág
1000...	1000 (Racores universales)	3.05.04	65	2610 3/4...	2000 (Racores accesorios)	4.10.06	79
1010...	1000 (Racores universales)	3.05.04	65	2611...	2000 (Racores accesorios)	4.10.06	79
1020...	1000 (Racores universales)	3.05.03	64	2612...	S2000 (Racores accesorios SPRINT)	4.05.05	72
1050...	1000 (Racores universales)	3.05.02	63	2613...	2000 (Racores accesorios)	4.10.06	79
1063...	1000 (Racores universales)	3.05.02	63	2651...	1000 (Anillo sellador)	2.05.11	59
1093...	1000 (Racores universales)	3.05.03	64	2661...	1000 (Anillo sellador)	2.05.12	60
1170...	1000 (Racores universales)	3.05.05	66	2665...	1000 (Anillo sellador)	2.05.12	60
1210...	1000 (Racores universales)	3.05.05	66	2669...	1000 (Anillo sellador)	2.05.12	60
1220...	1000 (Racores universales)	3.05.05	66	3033...	2000 (Racores accesorios - colectores)	4.10.12	85
1230...	1000 (Racores universales)	3.05.04	65	3043...	2000 (Racores accesorios - colectores)	4.10.12	85
1250...	1000 (Racores universales)	3.05.04	65	3053...	2000 (Racores accesorios - colectores)	4.10.13	86
1303...	1000 (Racores universales)	3.05.06	67	5051...	5000 (Enchufes de liberación rápida)	5.05.03	89
1310...	1000 (Racores universales)	3.05.06	67	5052...	5000 (Enchufes de liberación rápida)	5.05.03	89
1320...	1000 (Racores universales)	3.05.06	67	5053...	5000 (Enchufes de liberación rápida)	5.05.03	89
1410...	1000 (Racores rápidos)	2.05.06	54	5053L...	5000L-5000LT (Enchufes de liberación rápida)	5.06.03	95
1420...	1000 (Racores rápidos)	2.05.06	54	5054...	5000 (Enchufes de liberación rápida)	5.05.03	89
1431...	1000 (Racores rápidos)	2.05.05	53	5055...	5000 (Enchufes de liberación rápida)	5.05.04	90
1463...	1000 (Racores rápidos)	2.05.03	51	5056...	5000 (Enchufes de liberación rápida)	5.05.04	90
1470...	1000 (Racores rápidos)	2.05.11	59	5057...	5000 (Enchufes de liberación rápida)	5.05.04	90
1493...	1000 (Racores rápidos)	2.05.05	53	5058...	5000 (Enchufes de liberación rápida)	5.05.04	90
1500...	1000 (Racores rápidos)	2.05.04	52	5081...	5000 (Enchufes de liberación rápida)	5.05.03	89
1501 5/3 M5	1000 (Racores rápidos)	2.05.05	53	5082...	5000 (Enchufes de liberación rápida)	5.05.03	89
1510...	1000 (Racores rápidos)	2.05.02	50	5083...	5000 (Enchufes de liberación rápida)	5.05.03	89
1511...	1000 (Racores rápidos)	2.05.02	50	5083L...	5000L-5000LT (Enchufes de liberación rápida)	5.06.03	95
1540...	1000 (Racores rápidos)	2.05.10	58	5084...	5000 (Enchufes de liberación rápida)	5.05.03	89
1541...	1000 (Racores rápidos)	2.05.04	52	5086...	5000 (Enchufes de liberación rápida)	5.05.04	90
1550...	1000 (Racores rápidos)	2.05.10	58	5087...	5000 (Enchufes de liberación rápida)	5.05.04	90
1560...	1000 (Racores rápidos)	2.05.03	51	5088...	5000 (Enchufes de liberación rápida)	5.05.04	90
1580...	1000 (Racores rápidos)	2.05.09	57	5150...	5000 (Enchufes de liberación rápida)	5.05.05	91
1590...	1000 (Racores rápidos)	2.05.10	58	5150L...	5000L-5000LT (Enchufes de liberación rápida)	5.06.03	95
1600...	1000 (Racores rápidos)	2.05.11	59	5180...	5000 (Enchufes de liberación rápida)	5.05.05	91
1610...	1000 (Racores rápidos)	2.05.07	55	5180L...	5000L-5000LT (Enchufes de liberación rápida)	5.06.03	95
1620...	1000 (Racores rápidos)	2.05.07	55	5350...	5000 (Enchufes de liberación rápida)	5.05.05	91
1631...	1000 (Tornillo hueco)	2.05.08-09	56, 57	5380...	5000 (Enchufes de liberación rápida)	5.05.05	91
1631...	6000 (Tornillo hueco)	1.05.12	12	5450...	5000 (Enchufes de liberación rápida)	5.05.05	91
1635...	1000 (Tornillo hueco)	2.05.08-09	56, 57	5480...	5000 (Enchufes de liberación rápida)	5.05.05	91
1703...	1000 (Racores rápidos)	2.05.13	61	5650...	5000 (Enchufes de liberación rápida)	5.05.05	91
1723...	1000 (Racores rápidos)	2.05.13	61	5680...	5000 (Enchufes de liberación rápida)	5.05.05	91
2003...	2000 (Racores accesorios)	4.10.10	83	5750...	5000 (Enchufes de liberación rápida)	5.05.06	92
2010...	2000 (Racores accesorios)	4.10.08	81	5780...	5000 (Enchufes de liberación rápida)	5.05.06	92
2013...	2000 (Racores accesorios)	4.10.07	80	5850...	5000 (Enchufes de liberación rápida)	5.05.06	92
2020...	2000 (Racores accesorios)	4.10.08	81	5880...	5000 (Enchufes de liberación rápida)	5.05.06	92
2021 M5-M5	2000 (Racores accesorios)	4.10.08	81	6432...	6000 (Racores super-rápidos)	1.05.08-09	8, 9
2023...	2000 (Racores accesorios)	4.10.11	84	6442...	6000 (Racores super-rápidos)	1.05.10	10
2033...	2000 (Racores accesorios)	4.10.11	84	6451...	6000 (Racores super-rápidos)	1.05.11	11
2040...	2000 (Racores accesorios)	4.10.10	83	6452...	6000 (Racores super-rápidos)	1.05.11	11
2043...	2000 (Racores accesorios)	4.10.11	84	6463...	6000 (Racores super-rápidos)	1.05.04	4
2050...	2000 (Racores accesorios)	4.10.08	81	6501 4-M5	6000 (Racores super-rápidos)	1.05.07	7
2060...	2000 (Racores accesorios)	4.10.09	82	6512...	6000 (Racores super-rápidos)	1.05.03	3
2070...	2000 (Racores accesorios)	4.10.09	82	6522...	6000 (Racores super-rápidos)	1.05.05	5
2080...	2000 (Racores accesorios)	4.10.09	82	6525...	6000 (Racores super-rápidos)	1.05.06	6
2090...	2000 (Racores accesorios)	4.10.10	83	6540...	6000 (Racores super-rápidos)	1.05.17	17
2500...	2000 (Racores accesorios)	4.10.02	75	6550...	6000 (Racores super-rápidos)	1.05.16-17	16, 17
2501...	2000 (Racores accesorios)	4.10.02	75	6555...	6000 (Racores super-rápidos)	1.05.21	21
2510...	2000 (Racores accesorios)	4.10.02	75	6560...	6000 (Racores super-rápidos)	1.05.18	18
2511...	2000 (Racores accesorios)	4.10.04	77	6580...	6000 (Racores super-rápidos)	1.05.15-16	15, 16
2520...	2000 (Racores accesorios)	4.10.03	76	6590...	6000 (Racores super-rápidos)	1.05.14-15	14, 15
2521...	2000 (Racores accesorios)	4.10.03	76	6593...	6000 (Racores super-rápidos)	1.05.16	16
2525...	2000 (Racores accesorios)	4.10.04	77	6600...	6000 (Racores super-rápidos)	1.05.18	18
2530...	2000 (Racores accesorios)	4.10.04	77	6610...	6000 (Racores super-rápidos)	1.05.13	13
2531...	2000 (Racores accesorios)	4.10.05	78	6620...	6000 (Racores super-rápidos)	1.05.12	12
2541...	S2000 (Racores accesorios SPRINT)	4.05.03	70	6621...	6000 (Racores super-rápidos)	1.05.07	7
2543...	2000 (Racores accesorios)	4.10.05	78	6622...	6000 (Racores super-rápidos)	1.05.11	11
2553...	2000 (Racores accesorios)	4.10.05	78	6632...	6000 (Racores super-rápidos)	1.05.12	12
2601...	2000 (Racores accesorios)	4.10.07	80	6700...	6000 (Racores super-rápidos)	1.05.19	19

Modelo	Serie	Sección	Pág
6708...	6000 (Racores super-rápidos)	1.05.21	21
6750...	6000 (Racores super-rápidos)	1.05.19	19
6800...	6000 (Racores super-rápidos)	1.05.20	20
6811...	6000 (Racores super-rápidos)	1.05.13	13
6850...	6000 (Racores super-rápidos)	1.05.19	19
6900...	6000 (Racores super-rápidos)	1.05.22	22
6950...	6000 (Racores super-rápidos)	1.05.21	21
7432...	7000 (Racores super-rápidos de tecnopol.)	1.10.04	26
7442...	7000 (Racores super-rápidos de tecnopol.)	1.10.03	25
7522...	7000 (Racores super-rápidos de tecnopol.)	1.10.02	24
7522...LF	7000 (Racores super-rápidos de tecnopol.)	1.10.02	24
7526...	7000 (Racores super-rápidos de tecnopol.)	1.10.03	25
7540...	7000 (Racores super-rápidos de tecnopol.)	1.10.12	34
7542...	7000 (Racores super-rápidos de tecnopol.)	1.10.04	26
7545...	7000 (Racores super-rápidos de tecnopol.)	1.10.12	34
7550...	7000 (Racores super-rápidos de tecnopol.)	1.10.12	34
7555...	7000 (Racores super-rápidos de tecnopol.)	1.10.11	33
7560...	7000 (Racores super-rápidos de tecnopol.)	1.10.13	35
7562...	7000 (Racores super-rápidos de tecnopol.)	1.10.05	27
7572...	7000 (Racores super-rápidos de tecnopol.)	1.10.05	27
7575...	7000 (Racores super-rápidos de tecnopol.)	1.10.13	35
7580...	7000 (Racores super-rápidos de tecnopol.)	1.10.11	33
7610...	7000 (Racores super-rápidos de tecnopol.)	1.10.07	29
7612...	7000 (Racores super-rápidos de tecnopol.)	1.10.09	31
7622...	7000 (Racores super-rápidos de tecnopol.)	1.10.06	28
7632...	7000 (Racores super-rápidos de tecnopol.)	1.10.08	30
7640...	7000 (Racores super-rápidos de tecnopol.)	1.10.07	29
7642...	7000 (Racores super-rápidos de tecnopol.)	1.10.10	32
7652...	7000 (Racores super-rápidos de tecnopol.)	1.10.06	28
7800...	7000 (Racores super-rápidos de tecnopol.)	1.10.11	33
7950...	7000 (Racores super-rápidos de tecnopol.)	1.10.13	35
8432...	8000 (Racores super-rápidos doble sujeción)	1.15.02	37
8512...	8000 (Racores super-rápidos doble sujeción)	1.15.02	37
8522...	8000 (Racores super-rápidos doble sujeción)	1.15.02	37
8540...	8000 (Racores super-rápidos doble sujeción)	1.15.03	38
8550...	8000 (Racores super-rápidos doble sujeción)	1.15.03	38
8580...	8000 (Racores super-rápidos doble sujeción)	1.15.03	38
8TRT	8TRT (Línea de tubería de corte)	6.05.04	99
H8512	H8000 (Racores super-rápidos doble sujeción)	1.16.02	40
H8522	H8000 (Racores super-rápidos doble sujeción)	1.16.02	40
H8540	H8000 (Racores super-rápidos doble sujeción)	1.16.03	41
H8550	H8000 (Racores super-rápidos doble sujeción)	1.16.03	41
H8580	H8000 (Racores super-rápidos doble sujeción)	1.16.03	41
MPL...	MPL (Regleta para manguera)	6.05.04	99
PNZ...	PNZ (Pinzas de corte de manguera)	6.05.04	99
PNZP-12	PNZP (Pinzas de corte de manguera)	6.05.04	99
PV...	PV (Manguera de PVC reforzada)	6.05.02	97
S2010...	S2000 (Racores accesorios SPRINT)	4.05.03	70
S2020...	S2000 (Racores accesorios SPRINT)	4.05.03	70
S2050...	S2000 (Racores accesorios SPRINT)	4.05.04	71
S2060...	S2000 (Racores accesorios SPRINT)	4.05.04	71
S2070...	S2000 (Racores accesorios SPRINT)	4.05.04	71
S2080...	S2000 (Racores accesorios SPRINT)	4.05.05	72
S2090...	S2000 (Racores accesorios SPRINT)	4.05.05	72
S2500...	S2000 (Racores accesorios SPRINT)	4.05.02	69
S2510...	S2000 (Racores accesorios SPRINT)	4.05.03	70
S2520...	S2000 (Racores accesorios SPRINT)	4.05.02	69
S2530...	S2000 (Racores accesorios SPRINT)	4.05.02	69
S2610...	S2000 (Racores accesorios SPRINT)	4.05.05	72
S2615...	S2000 (Racores accesorios SPRINT)	4.05.06	73
S6110...	6000 (Racores super-rápidos)	1.05.14	14
S6430...	6000 (Racores super-rápidos)	1.05.08	8
S6440...	6000 (Racores super-rápidos)	1.05.09	9
S6450	6000 (Racores super-rápidos)	1.05.11	11
S6500...	6000 (Racores super-rápidos)	1.05.06	6

Modelo	Serie	Sección	Pág
S6510...	6000 (Racores super-rápidos)	1.05.02	2
S6510...-LF	6000 (Racores super-rápidos)	1.05.02	2
S6520...	6000 (Racores super-rápidos)	1.05.04	4
SP...	6000 (llaves desenganchadas)	1.05.22	22
TPC...	TPC (Manguera de poliuretano)	6.05.03	98
TPE...	TPE (Manguera de polietileno)	6.05.03	98
TRH...	TRH (Manguera de poliéster)	6.05.02	97
TRN...	TRN (Manguera de poliamida - nylon)	6.05.02	97
TSP...	TSP (Manguera en espiral de rylsan)	6.05.03	98
X6430...	X6000 (Racores super-rápidos)	1.25.04	45
X6432...	X6000 (Racores super-rápidos)	1.25.05	46
X6500...	X6000 (Racores super-rápidos)	1.25.03	44
X6510...	X6000 (Racores super-rápidos)	1.25.02	43
X6512...	X6000 (Racores super-rápidos)	1.25.02	43
X6520...	X6000 (Racores super-rápidos)	1.25.03	44
X6522...	X6000 (Racores super-rápidos)	1.25.04	45
X6540...	X6000 (Racores super-rápidos)	1.25.06	47
X6550...	X6000 (Racores super-rápidos)	1.25.06	47
X6580...	X6000 (Racores super-rápidos)	1.25.05	46
X6590...	X6000 (Racores super-rápidos)	1.25.06	47
X6800...	X6000 (Racores super-rápidos)	1.25.07	48

# Racores super-rápidos en latón Serie 6000 para tubos de plástico

Diámetros externos tubo: 3, 4, 5, 6, 8, 10, 12, 14, 16 mm  
Roscas de los racores: métricas (M3, M5, M6, M7), BSP (G1/8, G1/4, G3/8, G1/2, G3/4), BSPT (R1/8, R1/4, R3/8, R1/2)

RACORES SUPER-RÁPIDOS SERIE 6000



Los racores super-rápidos Serie 6000 han sido diseñados con una pinza especial que proporciona un agarre homogéneo en toda la superficie de los tubos de plástico, asegurando alta confiabilidad y una larga vida útil, aún después de muchas conexiones y desconexiones del tubo. La amplia gama de estos racores incluye varios tipos de roscas: métricas, BSP y BSPT.

Los modelos Sprint® con sistema patentado se caracterizan por una gran adaptabilidad de las roscas macho con las roscas hembra cilíndricas ISO-228 incluso en presencia de superficies no planas o irregulares. Esto es posible gracias a un anillo de Teflon en la rosca macho, lo cual garantiza un sellado perfecto entre las dos roscas.

El modelo "Racor con bloqueo" está disponible con un dispositivo de auto-retención el cual interrumpe el flujo de aire cuando el tubo neumático está desconectado, y lo restablece a la vez de reconectarlo.

## CARACTERÍSTICAS GENERALES

<b>Diámetros</b>	Ø 4 - 5 - 6 - 8 - 10 - 12 - 14 - 16 mm Micro modelos: Ø 3 - 4 - 6 - 8 - 10 mm
<b>Roscas</b>	GAS cónica ISO 7 (BSPT), GAS cilíndrica ISO 228 (BSP); M5-M6 y otras roscas métricas disponibles bajo pedido; NPT bajo pedido Micro modelos: M3 - M5 - M7 - G1/8 - G1/4
<b>Temperatura</b>	-20°C + 80°C (ver datos técnicos de la manguera usada) Micro modelos: -10°C + 80°C (ver datos técnicos del tubo usado)
<b>Tubo de conexión</b>	Rilsan, PA 6-11-12, Polietileno, Poliuretano PU, Poliester Hytrel
<b>Fluido</b>	aire comprimido (para otros tipos de fluidos, contactar con nuestros ingenieros)
<b>Materiales</b>	modelos estándar: cuerpo y pinza en latón niquelado, O-ring en NBR, sellos en las roscas en PTFE - NBR - PA modelos con dispositivo de auto-retención: cuerpo y pinza en latón niquelado válvulas de asiento en latón, resorte en acero inox., O-Ring en NBR, sellos de roscas en PTFE
<b>Presión</b>	modelos estándar: mín -0,9 bar - máx 16 bar (ver tubo) modelos con dispositivo de auto-retención: 0 ÷ 16 bar

## Racor con tubo de conexión

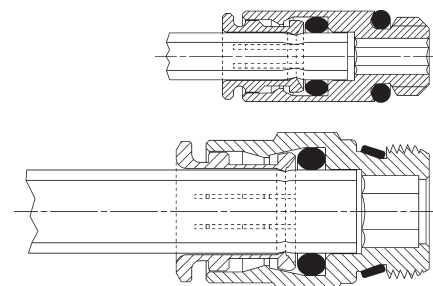



**Racores Mod. S6510**

Recto Macho Sprint®



DIMENSIONES										
Mod.	A	D	C	F	G	H	L	SW	SW1	Peso (g)
S6510 4-1/8	4	G1/8	3.8	8.8	13.2	5.5	18	12	2.5	9
S6510 4-1/4	4	G1/4	5.5	8.8	15.2	7	19.5	14	2.5	15
S6510 5-1/8	5	G1/8	3.8	9.8	13.2	5.5	19	12	3	8
S6510 5-1/4	5	G1/4	5.5	9.8	15.2	7	20	14	3	14
S6510 6-1/8	6	G1/8	6	11.7	13.2	5.5	22	12	4	10
S6510 6-1/4	6	G1/4	5.5	11.7	15.2	7	21	14	4	14
S6510 6-3/8	6	G3/8	6.5	11.7	20.5	8	22.5	19	4	27
S6510 8-1/8	8	G1/8	7.5	13.7	15.2	5.5	25	14	5	13
S6510 8-1/4	8	G1/4	6.5	13.7	15.2	7	24	14	6	14
S6510 8-3/8	8	G3/8	6	13.7	20.5	8	23.5	19	6	25
S6510 8-1/2	8	G1/2	7.5	13.7	24.5	9	25	22	6	43
S6510 10-1/4	10	G1/4	8.3	15.4	18.5	7	28.5	17	7	23
S6510 10-3/8	10	G3/8	5.3	15.4	20.5	8	25.5	19	8	27
S6510 10-1/2	10	G1/2	4.8	16	24.5	9	25	22	8	39
S6510 12-1/4	12	G1/4	10.3	18.3	20.5	7	29.5	19	7	26
S6510 12-3/8	12	G3/8	9.3	18.3	20.5	8	28.5	19	9	30
S6510 12-1/2	12	G1/2	5.8	18.3	24.5	9	25	22	10	36
S6510 14-3/8	14	G3/8	10.3	20.5	24.5	8	30.5	22	9	42
S6510 14-1/2	14	G1/2	6.3	20.5	24.5	9	26.5	22	12	34
S6510 16-1/2	16	G1/2	9	23.5	26.5	9	32	24	-	42
S6510 16-3/4	16	G3/4	3.5	23.5	27.3	9	26.5	24	-	46

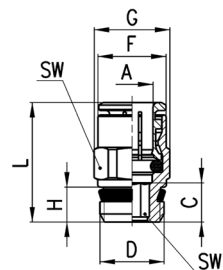

**Racores Mod. S6510...-LF**



Conector macho Sprint® con dispositivo de auto-retención

Esta versión evita la liberación de flujo de aire cuando el tubo se desconecta y la restaura una vez que se vuelve a conectar.

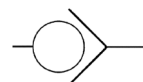
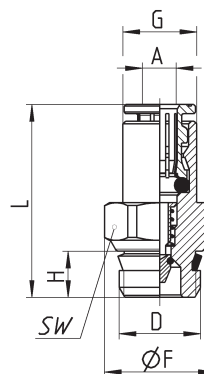

DIMENSIONES								
Mod.	A	D	F	G	H	L	SW	peso (g)
S6510 4-1/8-LF	4	G1/8	13.2	8.8	5.5	23	12	11
S6510 6-1/8-LF	6	G1/8	13.2	11.7	6	30.5	12	15

### Racores Mod. 6512 Micro

Recto macho Métrico-Cilíndrico

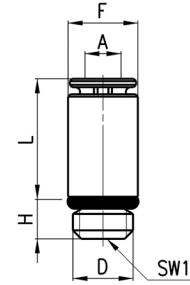

DIMENSIONES							
Mod.	A	D	F	H	L	SW1	Peso (g)
6512 3-M3	3	M3	5.8	2.5	10.2	1.5	1 *
6512 3-M5	3	M5	5.8	3.5	10	2	1 •
6512 4-M7-M	4	M7	9.4	5	17.5	2.5	5 •
6512 4-1/8-M	4	G1/8	11.2	5	13	2.5	9 •, Y
6512 6-M7-M	6	M7	10.4	5	17	4	7 •
6512 6-1/8-M	6	G1/8	11.2	5	14	4	7 •, Y
6512 8-1/8-M	8	G1/8	12.4	5	18.5	5	10 •, Y
6512 10-1/4-M	10	G1/4	14.8	6	21	7	16 •

\* = con junta  
• = con O-Ring

### Racores Mod. 6512

Recto Macho Métrico-Cilíndrico

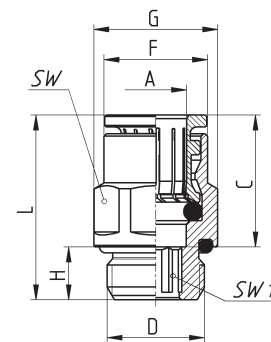

**Nuevas tallas**

DIMENSIONES										
Mod.	A	D	C	F	G	H	L	SW	SW1	Peso (g)
6512 4-M5	4	M5	14.0	7.8	8.8	4	20	8	2	4
6512 4-M6	4	M6	14.0	8.8	9.9	4.5	20.5	9	2.5	6
6512 4-1/8	4	G1/8	14.0	8.8	13.5	6	19	12	2.5	10
6512 4-1/4	4	G1/4	14.0	8.8	16.4	7	20.5	15	2.5	14
6512 5-M5	5	M5	15.0	8.8	9.9	4	21	9	2	5
6512 6-M5	6	M5	16.0	11.7	13.2	4	22	12	2	8
6512 6-M6	6	M6	16.0	11.7	13.2	4.5	22.5	12	2.5	8
6512 6-1/8	6	G1/8	16.0	11.7	13.5	6	21	12	4	10
6512 6-1/4	6	G1/4	16.0	11.7	16.4	7	22	15	4	13
6512 8-1/8	8	G1/8	17.5	13.7	15.2	6	26	14	5	15
6512 8-1/4	8	G1/4	17.5	13.7	16.4	7	24.5	15	6	17
6512 8-3/8	8	G3/8	17.5	13.7	20.5	7	23	19	6	27
6512 10-1/4	10	G1/4	20.2	15.4	18.5	7	30	17	7	26
6512 10-3/8	10	G3/8	20.2	15.4	20.5	7	24.5	19	8	27
6512 10-1/2	10	G1/2	20.2	15.4	24.8	8	25	22	8	39
6512 12-1/4	12	G1/4	19.2	18.3	20.5	7	29.5	19	7	29
6512 12-3/8	12	G3/8	19.2	18.3	20.5	7	24	19	9	24
6512 12-1/2	12	G1/2	19.2	18.3	24.8	8	24.5	22	9	37
6512 14-3/8	14	G3/8	20.2	20.5	24.5	7	30.5	22	10	38
6512 14-1/2	14	G1/2	20.2	20.5	24.8	8	25.5	22	10	35
6512 16-1/2	16	G1/2	23.0	23.5	26.5	8	33.5	24	-	49

**Racores Mod. 6463**

Recto Hembra Métrico-Cilíndrico

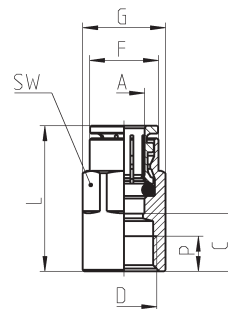

DIMENSIONES									
Mod.	A	D	C	F	G	L	P (min)	SW	Peso (g)
6463 4-M5	4	M5	6.5	7.8	8.8	20.5	4.5	9	8
6463 4-1/8	4	G1/8	10	9	13	24	6	12	14
6463 5-1/8	5	G1/8	10	9.8	13	25	6	12	14
6463 6-1/8	6	G1/8	10	11.7	13	26	6	12	14
6463 6-1/4	6	G1/4	11.5	11.9	16.5	27.5	7	15	23
6463 8-1/8	8	G1/8	9.5	13.7	15.2	27	6	14	16
6463 8-1/4	8	G1/4	11.5	13.7	16.5	29	7	15	23
6463 10-1/4	10	G1/4	11.3	15.4	18.5	31.5	7	17	29

**Racores Mod. S6520**

Codo Macho Giratorio Sprint®

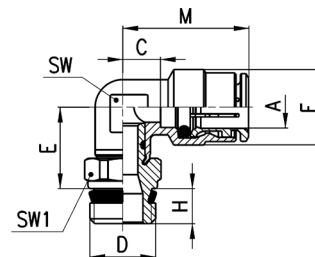

DIMENSIONES										
Mod.	A	D	C	E	F	H	M	SW	SW1	Peso (g)
S6520 4-1/8	4	G1/8	3.5	14.5	9	5.5	17.5	8	12	17
S6520 4-1/4	4	G1/4	3.5	14.5	9	7	17.5	8	14	23
S6520 5-1/8	5	G1/8	5.5	14.5	10	5.5	20.5	9	12	17
S6520 5-1/4	5	G1/4	5.5	14.5	10	7	20.5	9	14	23
S6520 6-1/8	6	G1/8	4	15	12.7	5.5	20	9	12	20
S6520 6-1/4	6	G1/4	4	15	12.7	7	20	9	14	23
S6520 6-3/8	6	G3/8	4	15.5	12.7	8	20	9	19	33
S6520 8-1/8	8	G1/8	5	16	14.2	5.5	22.5	11	12	22
S6520 8-1/4	8	G1/4	5	16	14.2	7	22.5	11	14	26
S6520 8-3/8	8	G3/8	5	16.5	14.2	8	22.5	11	19	41
S6520 8-1/2	8	G1/2	5	17	14.2	9	22.5	11	22	48
S6520 10-1/4	10	G1/4	5.8	18.5	16.5	7	26	13	14	32
S6520 10-3/8	10	G3/8	5.8	19	16.5	8	26	13	19	43
S6520 10-1/2	10	G1/2	5.8	19.5	16.5	9	26	13	22	62
S6520 12-1/4	12	G1/4	7.3	20	19.5	7	26.5	15	17	49
S6520 12-3/8	12	G3/8	7,3	20	19,5	8	26,5	15	19	48
S6520 12-1/2	12	G1/2	7,3	20,5	19,5	9	26,5	15	22	70
S6520 14-3/8	14	G3/8	8,3	21	21,5	8	28,5	17	19	74
S6520 14-1/2	14	G1/2	8,3	21,5	21,5	9	28,5	17	22	78

## Racores Mod. 6522 Micro

Codo Macho Giratorio Métrico

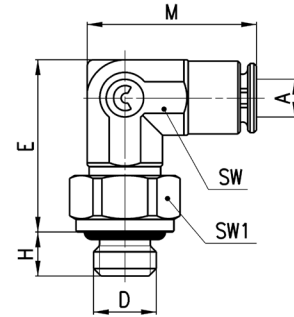

DIMENSIONES								
Mod.	A	D	E	H	M	SW	SW1	Peso (g)
6522 3-M3	3	M3	13.7	2.5	13.7	6	6	4 *
6522 3-M5	3	M5	13.7	3.5	13.7	6	8	5 •

\* = con junta  
• = con O-Ring

## Racores Mod. 6522

**Nuevas tallas**

Codo Macho Giratorio Métrico-Cilíndrico

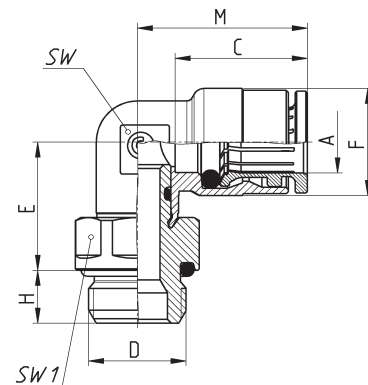

DIMENSIONES										
Mod.	A	D	C	E	F	H	M	SW	SW1	Peso (g)
6522 4-M5	4	M5	14.0	12.5	9	4	17.5	8	8	12
6522 4-1/8	4	G1/8	14.0	14.5	9	6	17.5	8	12	15
6522 4-1/4	4	G1/4	14.0	15.5	9	7	17.5	8	15	25
6522 5-M5	5	M5	15.0	12.5	10	4	20.5	9	8	13
6522 6-M5	6	M5	16.0	13	12.7	4	20	9	10	14
6522 6-1/8	6	G1/8	16.0	15	12.7	6	20	9	12	19
6522 6-1/4	6	G1/4	16.0	16	12.7	7	20	9	15	27
6522 8-1/8	8	G1/8	17.5	16	14.2	6	22.5	11	12	22
6522 8-1/4	8	G1/4	17.5	17	14.2	7	22.5	11	15	28
6522 8-3/8	8	G3/8	17.5	17	14.2	7	22.5	11	19	45
6522 10-1/4	10	G1/4	20.2	19.5	16.5	7	26	13	15	41
6522 10-3/8	10	G3/8	20.2	19.5	16.5	7	26	13	19	45
6522 10-1/2	10	G1/2	20.2	20.5	16.5	8	26	13	22	53
6522 12-1/4	12	G1/4	19.2	20	19.5	7	26.5	15	17	51
6522 12-3/8	12	G3/8	19.2	20.5	19.5	7	26.5	15	19	56
6522 12-1/2	12	G1/2	19.2	21.5	19.5	8	26.5	15	22	58
6522 14-3/8	14	G3/8	20.2	21.5	21.5	7	28.5	17	19	53
6522 14-1/2	14	G1/2	20.2	22.5	21.5	8	28.5	17	22	61

### Racores Mod. S6500

Codo Macho Fijo Métrico

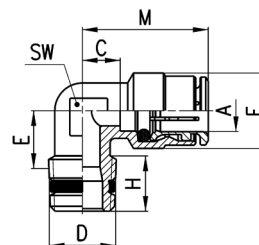

DIMENSIONES										
Mod.	A	D	C	E	F	H	M	SW	Peso (g)	
S6500 4-1/8	4	R1/8	3.5	8.5	9	7.5	17.5	8	9	
S6500 4-1/4	4	R1/4	5	11.5	9	12	19	9	13	
S6500 5-1/8	5	R1/8	5.5	8.5	10	7.5	20.5	9	13	
S6500 5-1/4	5	R1/4	5.5	11.5	10	12	20.5	9	17	
S6500 6-1/8	6	R1/8	4	9	12.7	7.5	20	9	15	
S6500 6-1/4	6	R1/4	4	11.5	12.7	12	20	9	16	
S6500 8-1/8	8	R1/8	5	10.5	14.2	6.5	22.5	11	18	
S6500 8-1/4	8	R1/4	5	11.5	14.2	12.5	22.5	11	21	
S6500 8-3/8	8	R3/8	7	13	14.2	11.5	24.5	12	25	
S6500 10-1/4	10	R1/4	5.8	13	16.5	11.5	26	13	33	
S6500 10-3/8	10	R3/8	5.8	13	16.5	12	26	13	33	
S6500 12-1/4	12	R1/4	7.3	14.5	19.5	11	26.5	15	46	
S6500 12-3/8	12	R3/8	7.3	13.5	19.5	11.5	26.5	15	39	

### Racores Mod. 6525

Codo Macho Giratorio Prolongado Sprint®

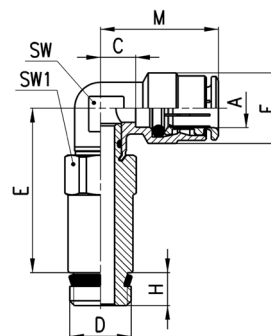

DIMENSIONES										
Mod.	A	D	C	E	F	H	M	SW	SW1	Peso (g)
6525 6-1/8	6	G1/8	4	33.8	12.7	5.5	20	9	12	34
6525 6-1/4	6	G1/4	4	34	12.7	7	20	9	14	47
6525 8-1/8	8	G1/8	5	34.8	14.2	5.5	22.5	11	12	35
6525 8-1/4	8	G1/4	5	35	14.2	7	22.5	11	14	50

### Racores Mod. 6621 Micro



Métrico Ajustable  
con Anillo Individual

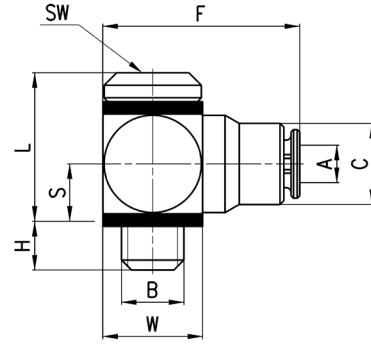

#### DIMENSIONES

Mod.	A	B	C	F	H	L	S	W	SW	Peso (g)
6621 3-M3	3	M3	5.8	14.2	2.5	9.3	3.5	6	1.5	5
6621 3-M5	3	M5	6.5	16	3.2	11.9	4.8	8	2	6

### Racor Mod. 6501 4-M5



Codo Macho Fijo Métrico

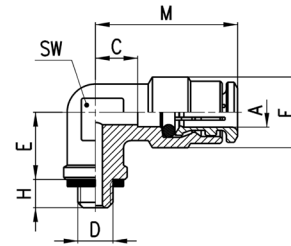

#### DIMENSIONES

Mod.	A	D	C	E	F	H	M	SW	Peso (g)
6501 4-M5	4	M5	3.5	6	9	4	17.5	8	11

### Racores Mod. S6430

Te Macho Giratorio Sprint®

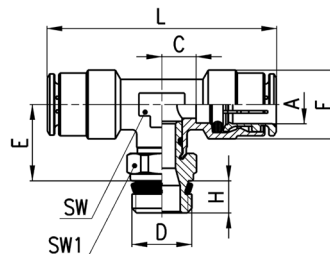

DIMENSIONES										
Mod.	A	D	C	E	F	H	L	SW	SW1	Peso (g)
S6430 4-1/8	4	G1/8	3.5	14.5	9	5.5	35	8	12	18
S6430 5-1/8	5	G1/8	5.5	14.5	10	5.5	41	9	12	24
S6430 5-1/4	5	G1/4	5.5	14.5	10	7	41	9	14	30
S6430 6-1/8	6	G1/8	4	15	12.7	5.5	40	9	12	28
S6430 6-1/4	6	G1/4	4	15	12.7	7	40	9	14	33
S6430 8-1/8	8	G1/8	5	16	14.2	5.5	45	11	12	37
S6430 8-1/4	8	G1/4	5	16	14.2	7	45	11	14	42
S6430 8-3/8	8	G3/8	5	16.5	14.2	8	45	11	19	51
S6430 10-1/4	10	G1/4	5.8	18.5	16.5	7	52	13	14	56
S6430 10-3/8	10	G3/8	5.8	19	16.5	8	52	13	19	67
S6430 10-1/2	10	G1/2	5.8	19.5	16.5	9	52	13	22	85
S6430 12-1/4	12	G1/4	7.3	20	19.5	7	53	15	17	60
S6430 12-3/8	12	G3/8	7.3	20	19.5	8	53	15	19	65
S6430 12-1/2	12	G1/2	7.3	20.5	19.5	9	53	15	22	89
S6430 14-1/2	14	G1/2	8.3	21.5	21.5	9	57	17	22	88

### Racores Mod. 6432 Micro

Te Macho Giratorio Métrico

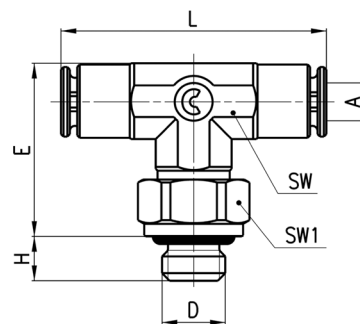

DIMENSIONES								
Mod.	A	D	E	H	L	SW	SW1	Peso (g)
6432 3-M3	3	M3	13.7	2.5	21.4	6	6	5
6432 3-M5	3	M5	13.7	3.5	21.4	6	8	6

\* = con junta  
● = con O-Ring

## Racores Mod. 6432

### Te Macho Giratorio Métrico-Cilíndrico

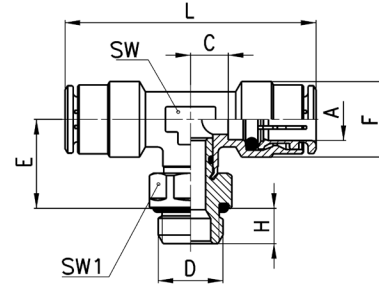

DIMENSIONES										
Mod.	A	D	C	E	F	H	L	SW	SW1	Peso (g)
6432 4-M5	4	M5	3.5	12.5	9	4	35	8	8	14
6432 4-1/8	4	G1/8	3.5	14.5	9	6	35	8	12	19
6432 5-M5	5	M5	5.5	12.5	10	4	41	9	8	19
6432 6-1/8	6	G1/8	4	15	12.7	6	40	9	12	29
6432 6-1/4	6	G1/4	4	16	12.7	7	40	9	15	30
6432 8-1/8	8	G1/8	5	16	14.2	6	45	11	12	37
6432 8-1/4	8	G1/4	5	17	14.2	7	45	11	15	39
6432 8-3/8	8	G3/8	5	17	14.2	7	45	11	19	55
6432 10-1/4	10	G1/4	5.8	19.5	16.5	7	52	13	15	59
6432 10-3/8	10	G3/8	5.8	19.5	16.5	7	52	13	19	56
6432 12-1/4	12	G1/4	7.3	20	19.5	7	53	15	17	60
6432 12-3/8	12	G3/8	7.3	20.5	19.5	7	53	15	19	80

## Racores Mod. S6440

### Te Macho Giratorio Lateral Sprint®

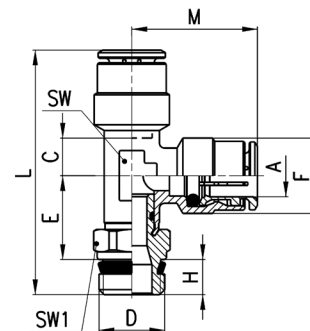

DIMENSIONES											
Mod.	A	D	C	E	F	H	L	M	SW	SW1	Peso (g)
S6440 4-1/8	4	G1/8	3.5	14.5	9	5.5	37.5	17.5	8	12	23
S6440 5-1/8	5	G1/8	5.5	14.5	10	5.5	40.5	20.5	9	12	24
S6440 6-1/8	6	G1/8	4	15	12.7	5.5	40.5	20	9	12	26
S6440 6-1/4	6	G1/4	4	15	12.7	7	42	20	9	14	31
S6440 8-1/8	8	G1/8	5	16	14.2	5.5	44	22.5	11	12	37
S6440 8-1/4	8	G1/4	5	16	14.2	7	45.5	22.5	11	14	35
S6440 8-3/8	8	G3/8	5	16.5	14.2	8	47	22.5	11	19	52
S6440 10-1/4	10	G1/4	5.8	18.5	16.5	7	51.5	26	13	14	43
S6440 10-3/8	10	G3/8	5.8	18.5	16.5	8	53	26	13	19	66
S6440 12-3/8	12	G3/8	7.3	19.5	19.5	8	54.5	26.5	15	19	65
S6440 14-1/2	14	G1/2	8.3	21.5	21.5	9	59	28.5	17	22	88



### Racores Mod. 6442 Micro



Te Macho Giratorio  
Lateral Métrico

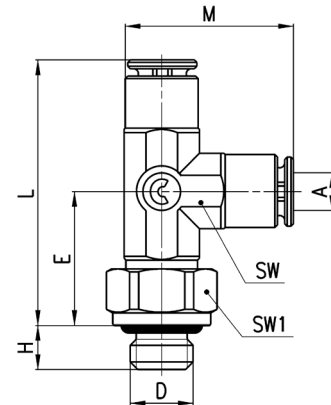

DIMENSIONES										
Mod.	A	D	E	H	L	M	SW	SW1	Peso (g)	
6442 3-M3	3	M3	10.7	2.5	21.4	13.7	6	6	5	*
6442 3-M5	3	M5	12.2	3.5	21.4	13.7	6	8	6	●

\* = con junta  
● = con O-Ring

### Racores Mod. 6442



Te Macho Giratorio  
Lateral Métrico-Cilíndrico

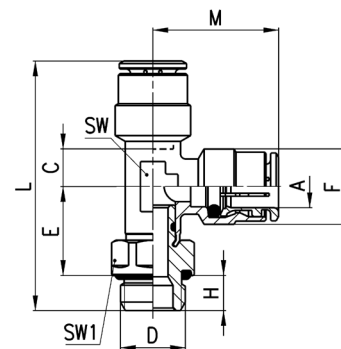

DIMENSIONES											
Mod.	A	D	C	E	F	H	L	M	SW	SW1	Peso (g)
6442 4-M5	4	M5	3.5	12.5	9	4	34	17.5	8	8	18
6442 4-1/8	4	G1/8	3.5	14.5	9	6	38	17.5	8	12	19
6442 5-M5	5	M5	5.5	12.5	10	4	36.5	20.5	9	8	19
6442 6-1/8	6	G1/8	4	15	12.7	6	41	20	9	12	26
6442 6-1/4	6	G1/4	4	16	12.7	7	43	20	9	15	36
6442 8-1/8	8	G1/8	5	16	14.2	6	44.5	22.5	11	12	31
6442 8-1/4	8	G1/4	5	17	14.2	7	46.5	22.5	11	15	42
6442 8-3/8	8	G3/8	5	17	14.2	7	46.5	22.5	11	19	50
6442 10-1/4	10	G1/4	5.8	19.5	16.5	7	52.5	26	13	15	46
6442 10-3/8	10	G3/8	5.8	19.5	16.5	7	52.5	26	13	19	66
6442 12-1/4	12	G1/4	7.3	20	16.5	7	53.5	26.5	15	17	73
6442 12-3/8	12	G3/8	7.3	20.5	19.5	7	54	26.5	15	19	64

### Racores Mod. 6452 Micro



Y Macho Giratorio Métrico

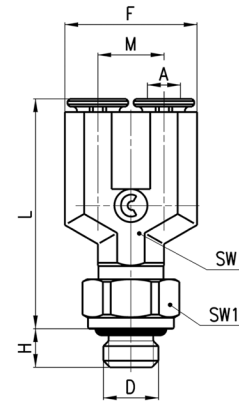

**DIMENSIONES**

Mod.	A	D	F	H	L	M	SW	SW1	Peso (g)
6452 3-M3	3	M3	12	2.5	20.9	6	6	6	6 *
6452 3-M5	3	M5	12	3.5	20.9	6	6	8	7 •

\* = con junta  
• = con O-Ring

### Racores Mod. 6451 y Mod. S6450



Mod. 6451: Y Macho Giratorio Métrico

Mod. S6450: Y Macho Giratorio Sprint®

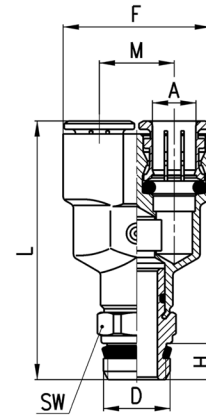

**DIMENSIONES**

Mod.	A	D	F	H	L	M	SW	Peso (g)
6451 4-M5	4	M5	18	4	26.5	9	-	17 *
6451 6-M5	6	M5	24.5	4	29.5	12.5	-	27 *
S6450 4-1/8	4	G1/8	18	5.5	38	9	12	23
S6450 6-1/8	6	G1/8	24.5	5.5	41.5	12.5	12	33
S6450 8-1/8	8	G1/8	28.5	5.5	48.5	14.5	14	48
S6450 8-1/4	8	G1/4	28.5	7	50	14.5	14	50

\* = modelo no giratorio con junta

### Racores Mod. 6622



Cilíndrico Giratorio con Anillo Individual

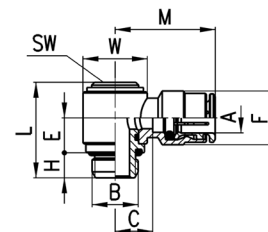

**DIMENSIONES**

Mod.	A	B	C	E	F	H	L	M	SW	W	Peso (g)
6622 4-M5	4	M5	4	5.7	8.8	4	15.8	18	2.5	Ø 8	10 *
6622 4-1/8	4	G1/8	7.5	10.2	9	5	25	21.5	4	Ø 14	22
6622 6-1/8	6	G1/8	8	10.2	12.7	5	25	24	4	Ø 14	24
6622 6-1/4	6	G1/4	10	9.1	12.7	6	25.3	26	5	Ø 18	35
6622 8-1/8	8	G1/8	8	10.2	14.2	5	25	25.5	4	Ø 14	28
6622 8-1/4	8	G1/4	10	9.1	14.2	6	25.3	27.5	5	Ø 18	39
6622 10-1/4	10	G1/4	8.8	9.1	16.5	6	25.3	29	5	Ø 18	42

\* = Métrico Giratorio con Anillo Individual

**Racores Mod. 6632**

Cilíndrico Giratorio con Anillo Doble

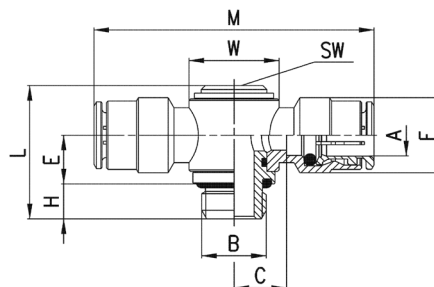

DIMENSIONES											
Mod.	A	B	C	E	F	H	L	M	W	SW	Peso (g)
6632 4-1/8	4	G1/8	7.5	10.2	9	5	25	43	∅ 14	4	24
6632 6-1/8	6	G1/8	8	10.2	12.7	5	25	48	∅ 14	4	33
6632 6-1/4	6	G1/4	10	9.1	12.7	6	25.3	52	∅ 18	5	35
6632 8-1/8	8	G1/8	8	10.2	14.2	5	25	51	∅ 14	4	39
6632 8-1/4	8	G1/4	10	9.1	14.2	6	25.3	55	∅ 18	5	40
6632 10-1/4	10	G1/4	8.8	9.1	16.5	6	25.3	58	∅ 18	5	50

**Racores Mod. 6620**

Anillo Doble

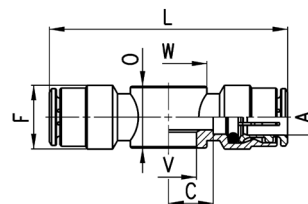

DIMENSIONES									
Mod.	A	C	F	L	O	V	W	Peso (g)	ensamblables con Mod.
6620 4-M5	4	5	9	38	9	5.1	∅ 9	13	SCU, SVU, SCO...
6620 4-1/8	4	7.5	9	43	14.5	9.8	∅ 14	19	1631, 1635, SCU, SVU, SCO...
6620 6-1/8	6	8	12.7	48	14.5	9.8	∅ 14	24	1631, 1635, SCU, SVU, SCO...
6620 6-1/4	6	10	12.7	52	14.5	13.2	∅ 18	26	1631, 1635, SCU, SVU, SCO...
6620 8-1/8	8	8	14.2	51	14.5	9.8	∅ 14	32	1631, 1635, SCU, SVU, SCO...
6620 8-1/4	8	10	14.2	55	14.5	13.2	∅ 18	34	1631, 1635, SCU, SVU, SCO...

**Racores Mod. 1631 suministrados con juntas**

- 01... = Tornillo Simple
- 02... = Tornillo Doble
- 03... = Tornillo Triple



Mod.
1631 01-
1631 02-
1631 03-

Diseños y dimensiones a la página 2.05.09

## Racores Mod. 6610

### Anillo Individual

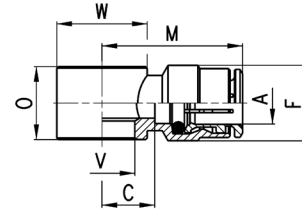

DIMENSIONES									
Mod.	A	C	F	M	O	V	W	Peso (g)	ensamblables con Mod.
6610 4-M5	4	5	9	19	9	5.1	9	9	1631
6610 4-M6	4	5	9	19	9	5.1	9	8	SCU, SVU, SCO...
6610 4-1/8	4	7.5	9	21.5	14.5	9.8	∅ 14	14	1631, 1635, SCU, SVU, SCO...
6610 5-M5	5	5	10	20	9	5.1	9	9	1631
6610 5-M6	5	5	10	20	9	5.1	9	8	SCU, SVU, SCO...
6610 5-1/8	5	8	10	23	14.5	9.8	∅ 14	16	1631, 1635, SCU, SVU, SCO...
6610 6-M5	6	6.5	12.7	22.5	9	5.1	∅ 10	12	1631
6610 6-M6	6	6.5	12.7	22.5	9	5.1	∅ 10	12	SCU, SVU, SCO...
6610 6-1/8	6	8	12.7	24	14.5	9.8	∅ 14	16	1631, 1635, SCU, SVU, SCO...
6610 6-1/4	6	10	12.7	26	14.5	13.2	∅ 18	19	1631, 1635, SCU, SVU, SCO...
6610 8-1/8	8	8	14.2	25.5	14.5	9.8	∅ 14	19	1631, 1635, SCU, SVU, SCO...
6610 8-1/4	8	10	14.2	27.5	14.5	13.2	∅ 18	22	1631, 1635, SCU, SVU, SCO...
6610 8-3/8	8	11	14.2	28.5	14.5	16.7	∅ 21	23	1631, 1635, SCU, SVU, SCO...
6610 10-1/4	10	8.8	16.5	29	14.5	13.2	∅ 18	22	1635, SCU, SVU, SCO...
6610 10-3/8	10	10.3	16.5	30.5	14.5	16.7	∅ 21	23	1635, SCU, SVU, SCO...
6610 12-1/2	12	12.8	16.5	32	14.5	21	∅ 26	37	1635

## Racores Mod. 6811

### Adaptador Macho Métrico Sprint®

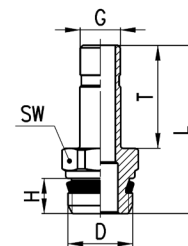

DIMENSIONES							
Mod.	G	D	H	T	L	SW	Peso (g)
6811 4-M5	4	M5	4	16.5	24.5	8	3 *
6811 4-1/8	4	G1/8	5.5	16.5	27.8	12	10
6811 5-1/8	5	G1/8	5.5	18	29.3	12	9
6811 5-1/4	5	G1/4	7	18	31	14	11
6811 6-1/8	6	G1/8	5.5	18	29.3	12	10
6811 6-1/4	6	G1/4	7	18	31	14	12
6811 8-1/8	8	G1/8	5.5	20.5	31.8	12	12
6811 8-1/4	8	G1/4	7	20.5	33.5	14	13
6811 10-1/4	10	G1/4	7	23	36	14	16
6811 10-3/8	10	G3/8	8	23	37.3	19	25
6811 12-3/8	12	G3/8	8	24	38.3	19	25
6811 14-1/2	14	G1/2	9	28	44	22	39

\* = con O-Ring

**Racores Mod. S6110**



Codo 45° Macho Giratorio Sprint®

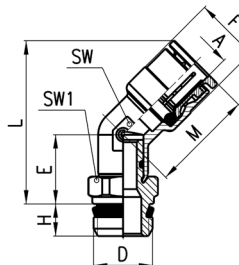

DIMENSIONES										
Mod.	A	D	E	F	H	L	M	SW	SW1	Peso (g)
S6110 6-1/8	6	G1/8	14	12.7	5.5	32.5	20.5	11	12	21
S6110 6-1/4	6	G1/4	14	12.7	7	34.5	20.5	11	14	25
S6110 8-1/8	8	G1/8	14	14.2	5.5	32.5	22.5	11	12	21
S6110 8-1/4	8	G1/4	14	14.2	7	34.5	22.5	11	14	26
S6110 8-3/8	8	G3/8	14.5	14.2	8	35	22.5	11	19	38
S6110 10-1/4	10	G1/4	15.5	16.5	7	39.5	26.5	15	17	39
S6110 10-3/8	10	G3/8	15.5	16.5	8	39.5	26.5	15	19	44
S6110 10-1/2	10	G1/2	16	16.5	9	40	26.5	15	22	57
S6110 12-1/4	12	G1/4	15.5	19.5	7	40.5	26.5	15	17	41
S6110 12-3/8	12	G3/8	15.5	19.5	8	40.5	26.5	15	19	46
S6110 12-1/2	12	G1/2	16	19.5	9	41	26.5	15	22	59

**Racores Mod. 6590 Micro**

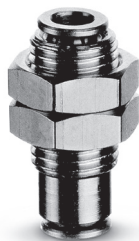

Pasatabiques

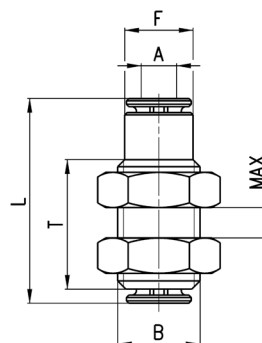

DIMENSIONES							
Mod.	A	B	F	L	MAX	T	Peso (g)
6590 3	3	M7x0.75	5.8	18.4	5	11.4	4

### Racores Mod. 6590

Pasatabiques

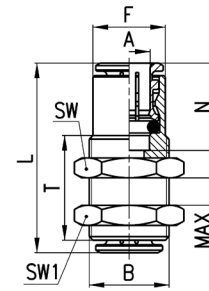

DIMENSIONES										
Mod.	A	B	F	L	N	MAX	SW	SW1	T	Peso (g)
6590 4	4	M10x1	8.8	29	14	10.5	14	14	20	16
6590 5	5	M12x1	9.8	31	15	10.5	17	17	20	25
6590 6	6	M14x1	12.5	33	16	10.5	17	17	20	28
6590 8	8	M16x1	14.5	36	17.5	11.5	19	19	21	35
6590 10	10	M18x1	16.3	41.5	20.2	13	22	22	23.5	51
6590 12	12	M20x1	18.8	39.5	19.2	14.5	24	24	25	56
6590 14	14	M22x1	20.5	41.5	20.2	17.5	27	27	30	82

### Racores Mod. 6580 Micro

Recto Intermedio

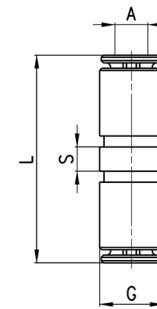

DIMENSIONES					
Mod.	A	G	L	S	Peso (g)
6580 3	3	5.8	19.9	2.2	2

### Racores Mod. 6580

Recto Intermedio

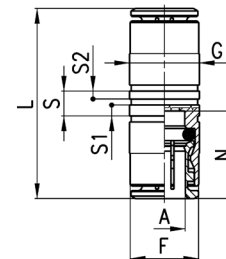

DIMENSIONES									
Mod.	A	F	G	L	N	S	S1	S2	Peso (g)
6580 4	4	8.4	9	29	14	5	2.2	1.6	11
6580 5	5	9.4	10	31	15	5	2.2	1.6	15
6580 6	6	11.7	12	34	16	5	2.2	1.6	16
6580 8	8	13.7	14	37	17.5	5	2.2	1.6	23
6580 10	10	15.4	17	41.5	20.2	5	2.2	1.6	33
6580 12	12	18.3	19	39.5	19.2	5.2	2.2	1.6	40
6580 14	14	20.5	21	41.5	20.2	5.2	2.2	1.6	47
6580 16	16	-	47	47	23	-	-	-	60

### Racores Mod. 6580 - Reducción

Reducción Recta Intermedia

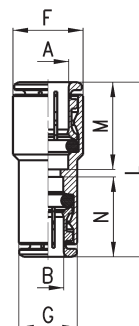

DIMENSIONES									
Mod.	A	B	F	G	L	M	N	Peso (g)	
6580 6-4	6	4	12	9	31.5	16	14	12	
6580 8-6	8	6	14	12.2	35	17.5	16	19	
6580 10-8	10	8	16	14	39	20	17.5	25	
6580 12-10	12	10	19	16	40.5	19	20	35	

### Racores Mod. 6593

Pastabiques Hembra Cilíndrica

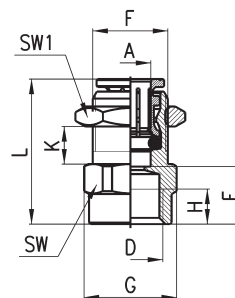

DIMENSIONES												
Mod.	A	D	E	F	G	H	L	K (max)	K (min)	SW	SW1	Peso (g)
6593 6-1/8	6	G1/8	10	M12x1	16.4	6	24.5	8.5	2	15	17	19
6593 6-1/4	6	G1/4	11.5	M12x1	18.5	7	26	6.5	2	17	17	22
6593 8-1/8	8	G1/8	10	M15x1	18.5	6	27	9.5	2	17	19	26
6593 8-1/4	8	G1/4	11.5	M15x1	18.5	7	28.5	9.5	2	17	19	26
6593 10-3/8	10	G3/8	12.8	M18x1	24.5	8	32.5	12	2	22	22	43

### Racores Mod. 6550 Micro

Codo Intermedio

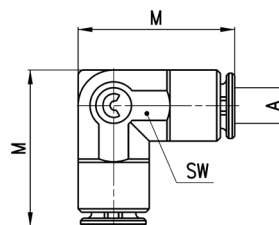

DIMENSIONES				
Mod.	A	M	SW	Peso (g)
6550 3	3	13.7	6	3

### Racores Mod. 6550

Codo Intermedio

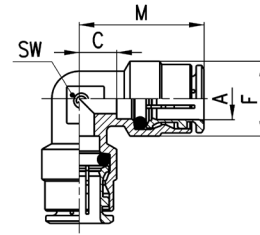

DIMENSIONES						
Mod.	A	C	F	M	SW	Peso (g)
6550 4	4	3.5	9	17.5	8	8
6550 5	5	5.5	10	20.5	9	15
6550 6	6	4	12.7	20	9	17
6550 8	8	5	14.2	22.5	11	22
6550 10	10	5.8	16.5	26	13	30
6550 12	12	7.3	19.5	26.5	15	44
6550 14	14	8.3	21.5	28.5	17	71

### Racores Mod. 6540 Micro

Te Intermedio

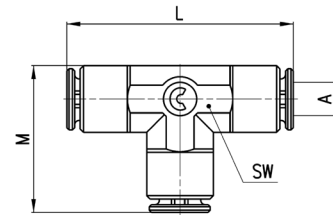

DIMENSIONES					
Mod.	A	L	M	SW	Peso (g)
6540 3	3	21.4	13.7	6	4

### Racores Mod. 6540

Te Intermedio

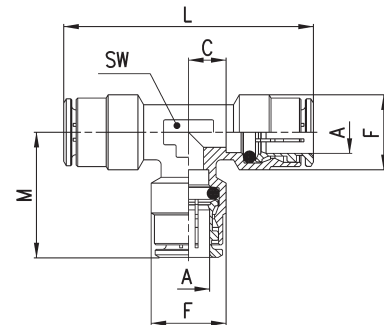

DIMENSIONES							
Mod.	A	C	F	L	M	SW	Peso (g)
6540 4	4	3.5	9	35	17.5	8	14
6540 5	5	5.5	10	41	20.5	9	21
6540 6	6	4	12.7	40	20	9	24
6540 8	8	5	14.2	45	22.5	11	32
6540 10	10	5.8	16.5	52	26	13	43
6540 12	12	7.3	19.5	53	26.5	15	60
6540 14	14	8.3	21.5	57	28.5	17	75



**Racores Mod. 6600**



Cruz Intermedio

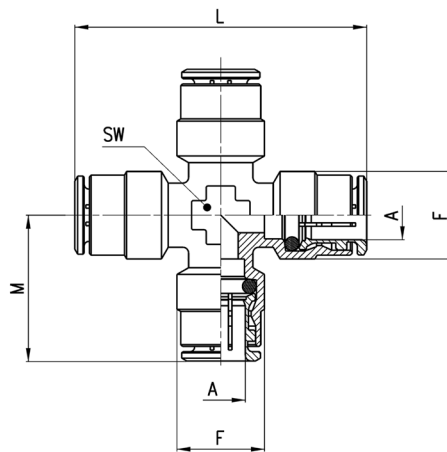

DIMENSIONES						
Mod.	A	F	L	M	SW	Peso (g)
6600 4	4	9	38	19	9	26
6600 5	5	10	41	20.5	9	29
6600 6	6	12.7	44	22	10	35
6600 8	8	14.2	49	24.5	12	50
6600 10	10	16.5	55	27.5	14	63
6600 12	12	19.5	56	28	16	84

**Racores Mod. 6560 Micro**

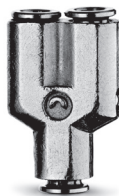

Y Intermedio

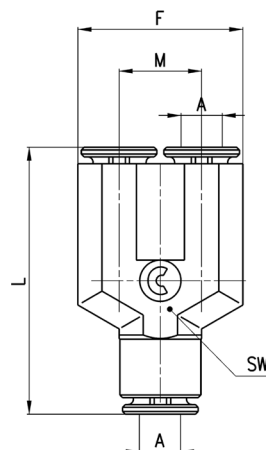

DIMENSIONES						
Mod.	A	F	L	M	SW	Peso (g)
6560 3	3	12	20.4	6	6	5

**Racores Mod. 6560**



Y Intermedio

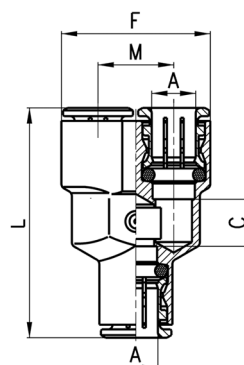

DIMENSIONES						
Mod.	A	C	F	L	M	Peso (g)
6560 4	4	5	18	33	9	19
6560 6	6	7	24.5	39	12.5	30
6560 8	8	9	28.5	44	14.5	42
6560 10	10	15.5	32	53.5	16	63

### Racores Mod. 6700

Cartucho



S\* = por asiento metálico  
y por asiento sintético

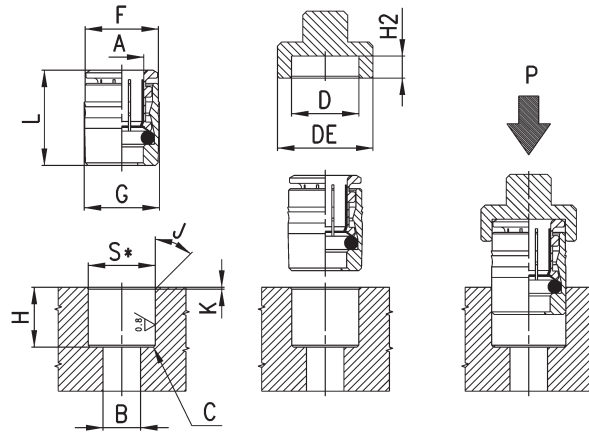

Mod.	A	B	C	D	DE	F	G	H	H2 (+0,1/0)	J	K	L	P min (Kg)	P max (Kg)	S (+0,01/-0,04)	Peso (g)
6700 3	3	2	0.5x45°	6.1	11	5.9	6.2	6.3	2.6	30°	0.3	9.2	80	350	6	1
6700 4	4	3.5	0.5x45°	8.8	14	8.6	9	11	3.3	15°	0.5	14.5	200	360	8.75	4
6700 5	5	3.5	0.5x45°	9.8	15	9.6	10	11.5	3.3	15°	0.5	15.5	230	450	9.75	5
6700 6	6	4	0.5x45°	12	17	11.8	12.2	12	3.8	15°	0.5	16.5	160	570	11.95	8
6700 8	8	6	0.5x45°	14	19	13.8	14.2	14	3.3	15°	0.5	18	140	400	13.95	11
6700 10	10	8	0.5x45°	16	21	15.8	16.2	16.5	3.5	15°	0.5	20.5	150	650	15.95	15

### Racores Mod. 6750

Tapón Hembra

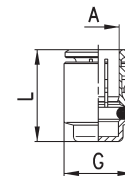

DIMENSIONES				
Mod.	A	G	L	Peso (g)
6750 4	4	8.8	15	4
6750 6	6	11.8	17	7
6750 8	8	13.8	18.5	9
6750 10	10	15.8	21	12
6750 12	12	17.8	20	15

### Racores Mod. 6850

Aumento

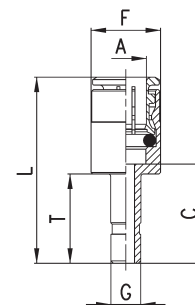

DIMENSIONES							
Mod.	A	G	C	F	L	T	Peso (g)
6850 6-4	6	4	17.5	12.7	33.5	16.5	11
6850 8-6	8	6	19	14	36.5	18	15

**Racores Mod. 6800 Micro**



Reducción

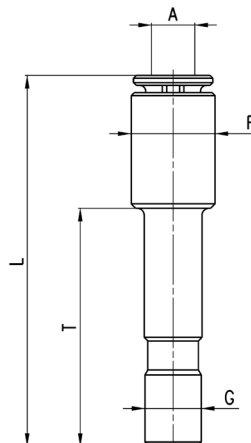

DIMENSIONES						
Mod.	A	F	G	L	T	Peso (g)
6800 3-4	3	5.8	4	26	16.5	2

**Racores Mod. 6800**



Reducción

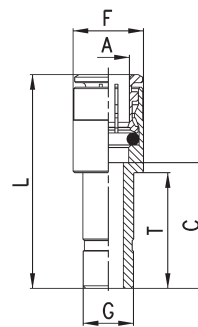

DIMENSIONES							
Mod.	A	G	C	F	L	T	Peso (g)
6800 4-5	4	5	19	9	33	18	8
6800 4-6	4	6	15.5	9	29.5	18	9
6800 4-8	4	8	18	9	32	20.5	10
6800 5-6	5	6	19	10	34	18	11
6800 5-8	5	8	18	10	33	20.5	12
6800 6-8	6	8	18	12.7	34	20.5	12
6800 6-10	6	10	20.5	12.7	36.5	23	17
6800 6-12	6	12	17.5	12.7	33.5	24	21
6800 8-10	8	10	20.5	14	38	23	15
6800 8-12	8	12	21.5	14	39	24	22
6800 10-12	10	12	20.3	16.5	40.5	24	27
6800 10-14	10	14	24.3	16.5	44.5	28	33
6800 12-14	12	14	24.3	18.8	45.5	28	27

### Racores Mod. 6950



Unión

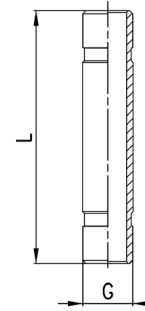

DIMENSIONES			
Mod.	G	L	Peso (g)
6950 4	4	32.5	3
6950 6	6	35.5	4
6950 8	8	40.5	7
6950 10	10	46	10
6950 12	12	48	13
6950 14	14	52	17

### Racores Mod. 6555



Codo con Espiga Injertable

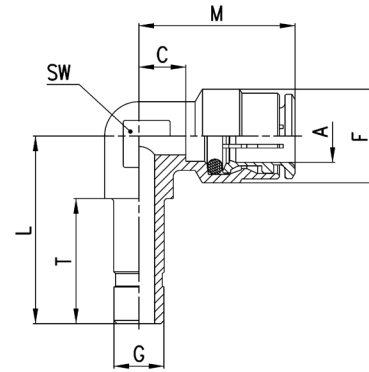

DIMENSIONES									
Mod.	A	G	C	L	F	T	M	SW	Peso (g)
6555 4-4	4	4	3.5	22	9	16.5	17.5	9	8
6555 6-6	6	6	4	24.5	12.7	18	20	9	14
6555 8-8	8	8	5	27.5	14.2	20	22.5	11	21
6555 10-10	10	10	5.8	32	16.5	23	26	13	26

### Accesorio Mod. 6708



Capuchón de protección  
Color negro,  
Material autoextinguible, Clase V0

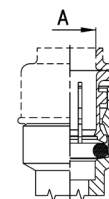
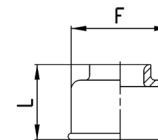

DIMENSIONES				
Mod.	A	F	L	Peso (g)
6708 4	4	10.7	10.7	1
6708 5	5	11.7	11	1
6708 6	6	13.7	11.5	1
6708 8	8	15.7	12.5	1
6708 10	10	18.5	13	1
6708 12	12	20.7	15	2
6708 14	14	23.7	15	2

**Accesorio Mod. 6900 Micro**



Tapón Macho de plástico

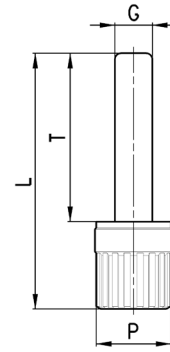

DIMENSIONES					
Mod.	G	L	P	T	Peso (g)
6900 3	3	20.5	6	13.5	1

**Accesorio Mod. 6900**



Tapón Macho de plástico

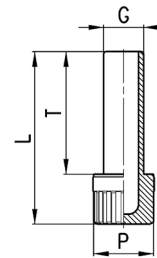

DIMENSIONES					
Mod.	G	L	P	T	Peso (g)
6900 4	4	29	8	20	1
6900 5	5	29.5	8	20.5	1
6900 6	6	31.5	8	22.5	1
6900 8	8	34.5	12	24.5	2
6900 10	10	37	12	27	2
6900 12	12	40.5	16	28.5	3
6900 14	14	42.5	16	30.5	3

**Accesorio Mod. SP**



Juego de llaves de desenganche

El juego incluye llaves desconectar tubos con diámetros de 4 a 12 mm.

Mod.
SP

# Racores super-rápidos Compact en tecnopolímero Serie 7000

Diámetros externos del tubo: 4, 6, 8, 10, 12, 16 mm  
Roscas de los racores: métricas (M5, M7),  
BSP (G1/8, G1/4, G3/8, G1/2, G3/4)

RACORES SUPER-RÁPIDOS COMPACT SERIE 7000

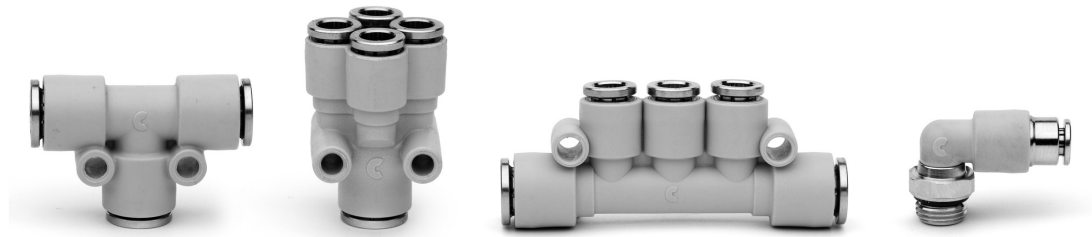

Los racores super-rápidos Compact Serie 7000 se realizan en tecnopolímero.

Compactos de peso ligero, estos racores son adecuados para aplicaciones donde el peso puede ser un factor clave.

La pinza especial, la cual ha sido diseñada propiamente para estas series, proporciona un agarre homogéneo en toda la superficie de los tubos de plástico, asegurando alta confiabilidad y una larga vida útil, aún después de muchas conexiones y desconexiones del tubo.

El modelo "Racor con bloqueo" está disponible con un dispositivo de auto-retención el cual interrumpe el flujo de aire cuando el tubo es desconectado, y restablece el flujo cuando el tubo es conectado nuevamente.

## CARACTERÍSTICAS GENERALES

<b>Diámetros</b>	Ø 4 - 6 - 8 - 10 - 12 - 16 mm
<b>Roscas</b>	GAS cilíndrica ISO-228 (BSP)
<b>Temperatura</b>	-20°C ÷ 60°C (ver datos técnicos del tubo usado)
<b>Tubo de conexión</b>	Rilsan, Poliamida PA 6-11-12, Polietileno, Poliuretano PU, Poliester Hytrel
<b>Fluido</b>	aire comprimido (para otros tipos de fluidos contactar con nuestros ingenieros)
<b>Materiales</b>	modelos estándar: cuerpo en tecnopolímero, inserto en latón; pinza en latón niquelado; sellos en NBR modelos con dispositivo de auto-retención: cuerpo en tecnopolímero, tuerca giratoria, inserto y pinza en latón niquelado
<b>Presión</b>	modelos estándar: -0,9 bar ÷ 16 bar (ver datos técnicos del tubo) modelos con dispositivo de auto-retención: 0 ÷ 16 bar

## Racor con tubo de conexión

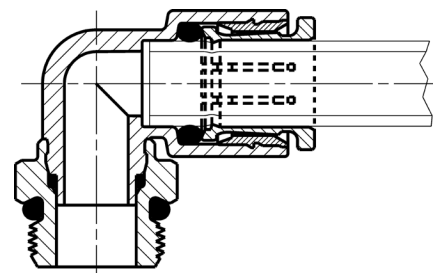

**Racores Mod. 7522**

Codo Giratorio Macho Métrico-Cilíndrico

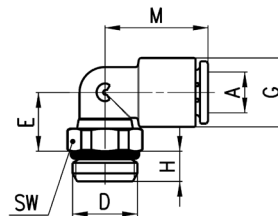

DIMENSIONES								
Mod.	A	D	E	G	H	M	SW	Peso (g)
7522 4-M5	4	M5	8.5	9.4	3.5	17	9	4
7522 4-M7	4	M7	11	9.4	5	17	10	6
7522 4-1/8	4	G1/8	9	9.4	5	17	12	7
7522 4-1/4	4	G1/4	9	9.4	6	17	14	10
7522 6-M5	6	M5	9.5	11.6	3.5	18.5	9	5
7522 6-M7	6	M7	12	11.6	5	18.5	10	7
7522 6-1/8	6	G1/8	10	11.6	5	18.5	12	8
7522 6-1/4	6	G1/4	10	11.6	6	18.5	14	11
7522 8-1/8	8	G1/8	13.5	13.9	5	20.5	12	11
7522 8-1/4	8	G1/4	12	13.9	6	20.5	14	13
7522 8-3/8	8	G3/8	12.5	13.9	7	20.5	19	21
7522 10-1/4	10	G1/4	14.5	16.1	6	24	14	15
7522 10-3/8	10	G3/8	13.5	16.1	7	24	19	21
7522 10-1/2	10	G1/2	13.5	16.1	8	24	24	30
7522 12-1/4	12	G1/4	16	20.2	6	28	17	20
7522 12-3/8	12	G3/8	15	20.2	7	28	19	25
7522 12-1/2	12	G1/2	15.5	20.2	8	28	24	34
7522 16-1/2	16	G1/2	30	27	8	33.5	24	61
7522 16-3/4	16	G3/4	24	27	9	33.5	30	70

**Racores Mod. 7522...LF**

Codo Giratorio Macho Métrico-Cilíndrico con dispositivo de auto-retención

Este modelo interrumpe el flujo de aire cuando el tubo es desconectado, y restablece el flujo cuando el tubo es conectado nuevamente.

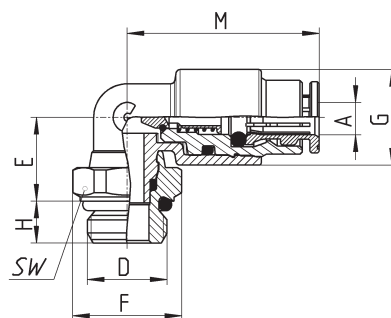

Mod.	A	D	E	F	G	H	M	SW	peso (g)
7522 4-1/8-LF	4	G1/8	10	13	1.6	5	23	12	11
7522 6-1/8-LF	6	G1/8	13.5	13	13.9	5	37.5	12	23

### Racores Mod. 7526

Codo Giratorio Macho  
Prolungado Cilíndrico

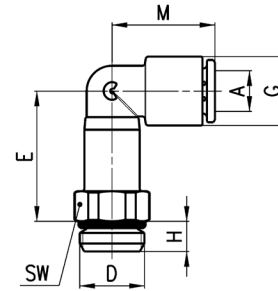

DIMENSIONES								
Mod.	A	D	E	G	H	M	SW	Peso (g)
7526 4-1/8	4	G1/8	22	9,4	5	17	12	12
7526 6-1/8	6	G1/8	23	11,6	5	18,5	12	13
7526 6-1/4	6	G1/4	23	11,6	5	18,5	14	16
7526 8-1/8	8	G1/8	29	13,9	5	20,5	12	18
7526 8-1/4	8	G1/4	27	13,9	6	20,5	14	20

### Racores Mod. 7442

Te Giratorio Macho Lateral  
Métrico-Cilíndrico

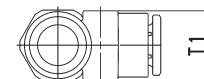
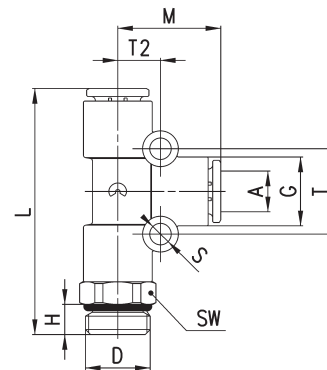

DIMENSIONES												
Mod.	A	D	G	H	L	M	S	T	T1	T2	SW	Peso (g)
7442 4-1/8	4	G1/8	9,4	5	40	16,5	4	13	9,2	6,5	12	11
7442 6-1/8	6	G1/8	11,6	5	44	18,5	4	15	11,4	7,5	12	15
7442 6-1/4	6	G1/4	11,6	6	45	18,5	4	15	11,4	7,5	14	18
7442 8-1/8	8	G1/8	13,9	5	49	20,5	4	17	13,7	8,5	14	23
7442 8-1/4	8	G1/4	13,9	6	49	20,5	4	17	13,7	8,5	17	22
7442 8-3/8	8	G3/8	13,9	7	50,5	20,5	4	17	13,7	8,5	19	29
7442 10-1/4	10	G1/4	16,1	6	57	24	4	16	15,8	8	17	32
7442 10-3/8	10	G3/8	16,1	7	57,5	24	4	16	15,8	8	19	33
7442 12-3/8	12	G3/8	20,2	7	65,5	28	4	19,2	9	9,6	19	51
7442 12-1/2	12	G1/2	20,2	8	66,5	28	4	19,2	9	9,6	24	58
7442 16-1/2	16	G1/2	27	8	71,5	33,5	-	-	-	-	24	80
7442 16-3/4	16	G3/4	27	9	66,5	33,5	-	-	-	-	30	90

\* = modelo sin agujeros de fijación



**Racores Mod. 7432**

Te Giratorio Macho Métrico-Cilíndrico

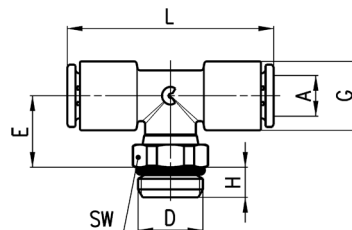

DIMENSIONES								
Mod.	A	D	E	G	H	L	SW	Peso (g)
7432 4-M5	4	M5	14	9,4	3,5	34	9	7
7432 4-1/8	4	G1/8	11,5	9,4	5	34	12	9
7432 6-M5	6	M5	15,5	11,6	3,5	37	9	9
7432 6-1/8	6	G1/8	13	11,6	5	37	12	11
7432 6-1/4	6	G1/4	13	11,6	6	37	14	13
7432 8-1/8	8	G1/8	16	13,9	5	41	12	15
7432 8-1/4	8	G1/4	14,5	13,9	6	41	14	17
7432 8-3/8	8	G3/8	15,5	13,9	7	41	19	25
7432 10-1/4	10	G1/4	18,5	16,1	6	48	14	21
7432 10-3/8	10	G3/8	17,5	16,1	7	48	19	27
7432 12-1/4	12	G1/4	31,5	20,2	6	56	20	49
7432 12-3/8	12	G3/8	30,5	20,2	7	56	20	51
7432 12-1/2	12	G1/2	30,5	20,2	8	56	24	58
7432 16-1/2	16	G1/2	30	27	8	67	24	80
7432 16-3/4	16	G3/4	24	27	9	67	30	90

**Racores Mod. 7542**

Multi Te Reducido Giratorio Macho Cilíndrico

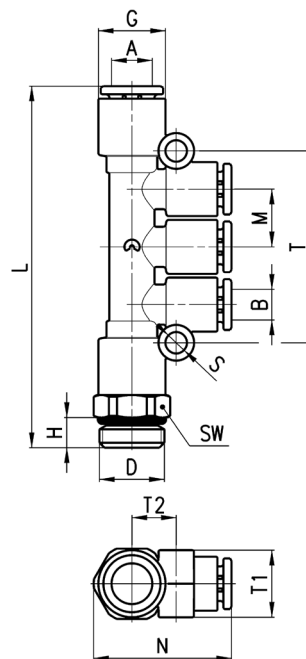

DIMENSIONES														
Mod.	A	B	D	G	H	L	M	N	S	SW	T	T1	T2	Peso (g)
7542 6-4-1/8	6	4	G1/8	11,6	5	62,5	9,6	24,5	4	12	32,5	11	7,5	18
7542 6-4-1/4	6	4	G1/4	11,6	6	63,5	9,6	25,5	4	14	32,5	11	7,5	21
7542 8-6-1/8	8	6	G1/8	13,9	5	72	11,5	27,5	4	14	38,2	13,5	9	28
7542 8-6-1/4	8	6	G1/4	13,9	6	72	11,5	27,5	4	14	38,2	13,5	9	26
7542 10-8-1/4	10	8	G1/4	16,1	6	87,5	14,1	31	4	17	45,8	16	10,5	41
7542 10-8-3/8	10	8	G3/8	16,1	7	88	14,1	32	4	19	45,8	16	10,5	42

### Racores Mod. 7562

Y Giratorio Macho Cilíndrico

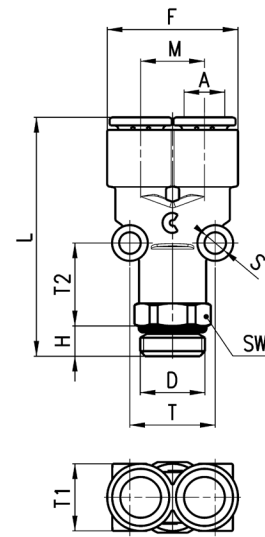

DIMENSIONES												
Mod.	A	D	F	H	L	M	S	SW	T	T1	T2	Peso (g)
7562 4-1/8	4	G1/8	18,5	5	40,5	9	4	12	12,2	11,6	16,5	13
7562 6-1/8	6	G1/8	23	5	44	11,4	4	14	14,5	14	18,5	15
7562 6-1/4	6	G1/4	23	6	44	11,4	4	14	14,5	14	17,5	29
7562 8-1/8	8	G1/8	27,2	5	47,5	13,5	4	14	17	14	17,5	24
7562 8-1/4	8	G1/4	26,2	6	49	12,7	4	17	16,5	15,5	19,5	30
7562 10-1/4	10	G1/4	31,7	6	55	15,8	4	17	16,5	16	19,5	32
7562 10-3/8	10	G3/8	31,7	7	55,5	15,8	4	19	16,5	16	19	34

### Racores Mod. 7572

Y Doble Giratorio Macho Cilíndrico

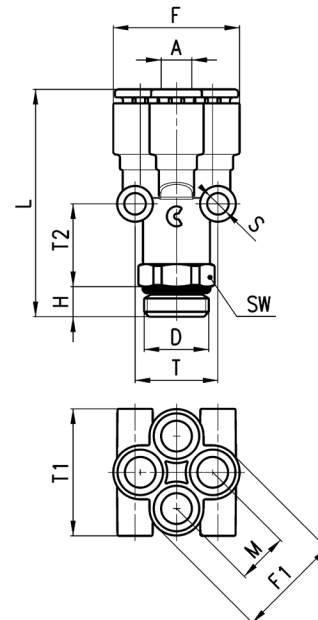

DIMENSIONES													
Mod.	A	D	H	F	F1	L	M	S	SW	T	T1	T2	Peso (g)
7572 4-1/8	4	G1/8	5	20,5	17	40,5	8,3	4	12	14,5	20,5	15	17
7572 4-1/4	4	G1/4	6	20,5	17	41,5	8,3	4	14	14,5	20,5	15	21
7572 6-1/8	6	G1/8	5	25	21	45,5	10,2	4	14	16,5	25	17,5	27
7572 6-1/4	6	G1/4	6	25	21	45,5	10,2	4	14	16,5	25	16,5	25

### Racores Mod. 7622

Giratorio Cilíndrico con Anillo Individual

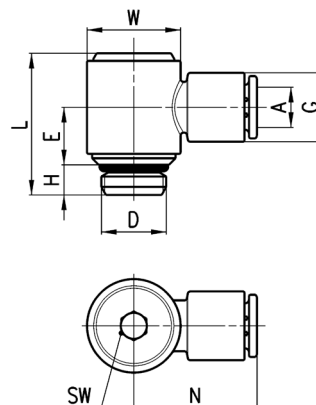

DIMENSIONES										
Mod.	A	D	E	G	H	L	N	W	SW	Peso (g)
7622 4-1/8	4	G1/8	10	11,6	5	24,5	21	14	4	12
7622 6-1/8	6	G1/8	10	11,6	5	24,5	21	14	4	12
7622 6-1/4	6	G1/4	12,5	11,6	6	28	24,5	18,5	5	25
7622 8-1/8	8	G1/8	10	13,9	5	24,5	22,5	14	4	14
7622 8-1/4	8	G1/4	12,5	13,9	6	28	24,5	18,5	5	26
7622 10-1/4	10	G1/4	12,5	16,1	6	28	27	18,5	5	27
7622 10-3/8	10	G3/8	12,5	16,1	7	29	27	18,5	5	28
7622 12-3/8	12	G3/8	14	20,2	7	33,5	29	22	5	43

### Racores Mod. 7652

Giratorio Cilíndrico con Anillo Doble

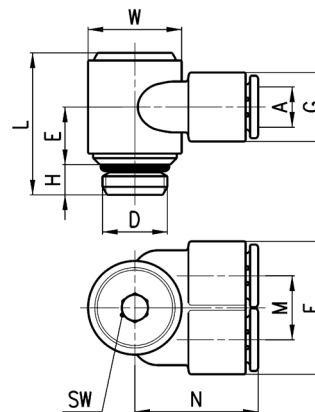

DIMENSIONES												
Mod.	A	D	E	F	G	H	L	M	N	W	SW	Peso (g)
7652 4-1/8	4	G1/8	10	22,3	11,6	5	24,5	10,7	21	14	4	15
7652 6-1/8	6	G1/8	10	22,3	11,6	5	24,5	10,7	21	14	4	15
7652 6-1/4	6	G1/4	11,5	26,6	11,6	6	28	12,7	24,5	18,5	5	29
7652 8-1/8	8	G1/8	10	26,6	13,9	5	24,5	12,7	22	14	4	18
7652 8-1/4	8	G1/4	11,5	26,6	13,9	6	28	12,7	24,5	18,5	5	30
7652 10-1/4	10	G1/4	11,5	31	16	6	28	15	26,5	18,5	5	33
7652 10-3/8	10	G3/8	11,5	31	16	7	29	15	26,5	18,5	5	34

**Racores Mod. 7610 ensamblables con Mod. 7632 02, 7632 03**

Anillo Simple

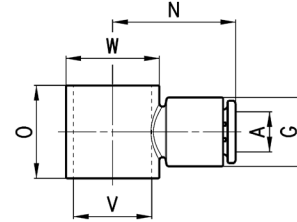

DIMENSIONES							
Mod.	A	G	N	O	V	W	Peso (g)
7610 4-1/8	4	11,6	21	15,5	11	14	3
7610 6-1/8	6	11,6	21	15,5	11	14	4
7610 6-1/4	6	13,9	24,5	18,5	15,5	18,5	6
7610 8-1/8	8	13,9	22,5	15,5	11	14	5
7610 8-1/4	8	13,9	24,5	18,5	15,5	18,5	7
7610 10-1/4	10	16,1	27	18,5	15,5	18,5	7
7610 10-3/8	10	20,2	29	22	18	22	11
7610 12-3/8	12	20,2	29	22	18	22	12

**Racores Mod. 7640 ensamblables con Mod. 7632 02, 7632 03**

Anillo Doble

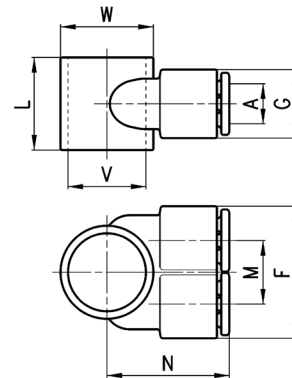

DIMENSIONES									
Mod.	A	F	G	L	M	N	V	W	Peso (g)
7640 4-1/8	4	22,3	11,6	15,5	10,7	21	11	14	6
7640 6-1/8	6	22,3	11,6	15,5	10,7	21	11	14	7
7640 6-1/4	6	26,6	13,9	18,5	12,7	24,5	15,5	18,5	9
7640 8-1/8	8	26,6	13,9	15,5	12,7	22	11	14	10
7640 8-1/4	8	26,6	13,9	18,5	12,7	24,5	15,5	18,5	10
7640 10-1/4	10	31	16	18,5	15	26,5	15,5	18,5	13

**Racores Mod. 7632 02 ensamblables con Mod. 7610, 7640**

Tornillo Doble

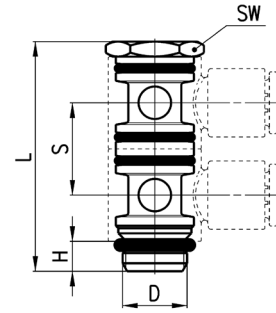

DIMENSIONES						
Mod.	D	H	L	S	SW	Peso (g)
7632 02-1/8	G1/8	5	38,5	15,5	13	14
7632 02-1/4	G1/4	6	46	18,5	17	29
7632 02-3/8	G3/8	7	54	22	20	45

**Racores Mod. 7632 03 ensamblables con Mod. 7610, 7640**

Tornillo Triple

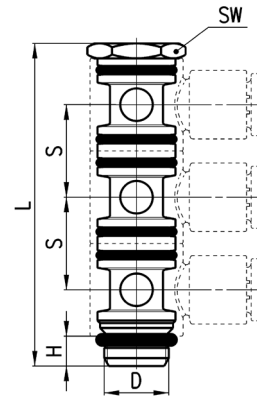

DIMENSIONES						
Mod.	D	H	L	S	SW	Peso (g)
7632 03-1/8	G1/8	5	54	15,5	13	18
7632 03-1/4	G1/4	6	64,5	18,5	17	39

### Racores Mod. 7612 02



Doble Giratorio Cilíndrico con Anillo Simple

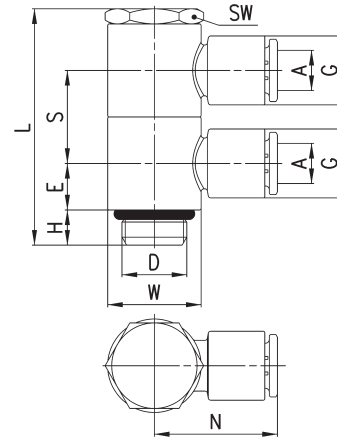

	A	D	E	G	H	L	N	S	W	SW	Peso (g)
7612 02-4-1/8	4	G1/8	7,75	11,6	5	38,5	21	15,5	14	13	21
7612 02-6-1/8	6	G1/8	7,75	11,6	5	38,5	21	15,5	14	13	21
7612 02-6-1/4	6	G1/4	9,25	13,9	6	46	24,5	18,5	18,5	17	40
7612 02-8-1/8	8	G1/8	7,75	13,9	5	38,5	22,5	15,5	14	13	24
7612 02-8-1/4	8	G1/4	9,25	13,9	6	46	24,5	18,5	18,5	17	42
7612 02-10-1/4	10	G1/4	9,25	16,1	6	46	27	18,5	18,5	17	44
7612 02-10-3/8	10	G3/8	11	20,2	7	54	29	22	22	20	67
7612 02-12-3/8	12	G3/8	11	20,2	7	54	29	22	22	20	69

### Racores Mod. 7612 03



Triple Giratorio Cilíndrico con Anillo Simple

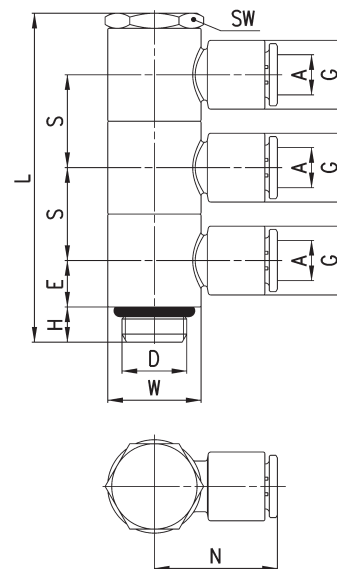

	A	D	E	G	H	L	N	S	W	SW	Peso (g)
7612 03-4-1/8	4	G1/8	7,75	11,6	5	54	21	15,5	14	13	29
7612 03-6-1/8	6	G1/8	7,75	11,6	5	54	21	15,5	14	13	30
7612 03-6-1/4	6	G1/4	9,25	13,9	6	64,5	24,5	18,5	18,5	17	55
7612 03-8-1/8	8	G1/8	7,75	13,9	5	54	22,5	15,5	14	13	34
7612 03-8-1/4	8	G1/4	9,25	13,9	6	64,5	24,5	18,5	18,5	17	57
7612 03-10-1/4	10	G1/4	9,25	16,1	6	64,5	27	18,5	18,5	17	62

**Racores Mod. 7642 02**



Doble Giratorio Cilíndrico con Anillo Doble

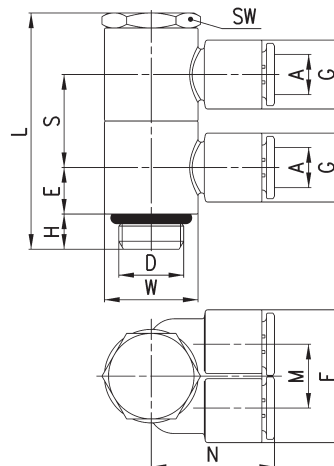

Mod.	A	D	E	F	G	H	L	M	N	S	W	SW	Peso (g)
7642 02-4-1/8	4	G1/8	7,75	22,3	11,6	5	38,5	10,7	21	15,5	14	13	26
7642 02-6-1/8	6	G1/8	7,75	22,3	11,6	5	38,5	10,7	21	15,5	14	13	28
7642 02-6-1/4	6	G1/4	9,25	26,6	13,9	6	46	12,7	24,5	18,5	18,5	17	48
7642 02-8-1/8	8	G1/8	7,75	26,6	13,9	5	38,5	12,7	22	15,5	14	13	33
7642 02-8-1/4	8	G1/4	9,25	26,6	13,9	6	46	12,7	24,5	18,5	18,5	17	50
7642 02-10-1/4	10	G1/4	9,25	31	16	6	46	15	26,5	18,5	18,5	17	56

**Racores Mod. 7642 03**



Triple Giratorio Cilíndrico con Anillo Doble

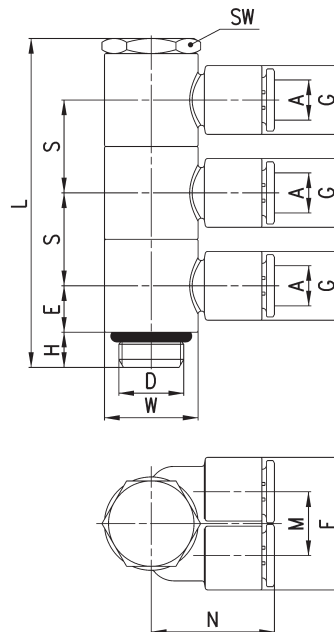

Mod.	A	D	E	F	G	H	L	M	N	S	W	SW	Peso (g)
7642 03-4-1/8	4	G1/8	7,75	22,3	11,6	5	54	10,7	21	15,5	14	13	37
7642 03-6-1/8	6	G1/8	7,75	22,3	11,6	5	54	10,7	21	15,5	14	13	39
7642 03-6-1/4	6	G1/4	9,25	26,6	13,9	6	64,5	12,7	24,5	18,5	18,5	17	67
7642 03-8-1/8	8	G1/8	7,75	26,6	13,9	5	54	12,7	22,5	15,5	14	13	47
7642 03-8-1/4	8	G1/4	9,25	26,6	13,9	6	64,5	12,7	24,5	18,5	18,5	17	71
7642 03-10-1/4	10	G1/4	9,25	31	16,1	6	64,5	15	27	18,5	18,5	17	79

### Racores Mod. 7800

Reducción

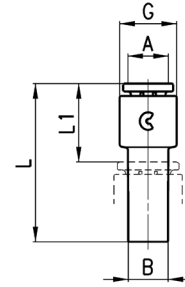

DIMENSIONES						
Mod.	A	B	G	L1	L	Peso (g)
7800 4-6	4	6	9,4	14,5	29,5	2
7800 4-8	4	8	9,4	14,5	30,5	3
7800 6-8	6	8	11,6	15,5	31,5	4
7800 6-10	6	10	11,6	15,5	34	4
7800 6-12	6	12	11,6	16,5	35,5	4
7800 8-10	8	10	13,9	16,5	35	5
7800 8-12	8	12	13,9	17,5	37	6
7800 10-12	10	12	16,1	18,5	37,5	7
7800 10-14	10	14	16,1	22,5	39	7

### Racores Mod. 7555

Codo con espiga Injertable

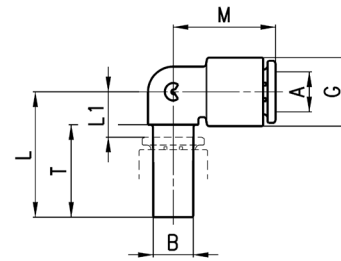

DIMENSIONES								
Mod.	A	B	G	L	L1	M	T	Peso (g)
7555 4-4	4	4	9,4	21	7	16,5	16,5	2
7555 6-6	6	6	11,6	23	8	18,5	17,5	4
7555 8-8	8	8	13,9	25	9	20,5	18,5	5
7555 10-10	10	10	16,1	28,5	10	24	21	8
7555 12-12	12	12	20,2	32	13	28	23	12

### Racores Mod. 7580

Recto Intermedio

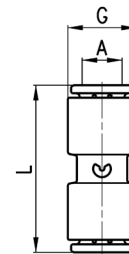

DIMENSIONES				
Mod.	A	G	L	Peso (g)
7580 4	4	9,4	29	4
7580 6	6	11,6	31	6
7580 8	8	13,9	33,5	9
7580 10	10	16,1	38,5	11
7580 12	12	20,2	39,5	18



### Racores Mod. 7550

Codo Intermedio

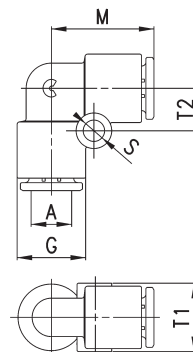

DIMENSIONES							
Mod.	A	G	M	S	T1	T2	Peso (g)
7550 4	4	9,4	16,5	4	9,2	6,5	4
7550 6	6	11,6	18,5	4	11,4	7,5	6
7550 8	8	13,9	20,5	4	13,7	8,5	9
7550 10	10	16,1	24	4	15,8	8	12
7550 12	12	20,2	28	4	9	9,6	20
7550 16	16	27	33,5	-	-	-	42 *

\* = modelo sin agujeros de fijación

### Racores Mod. 7540

Te Intermedio

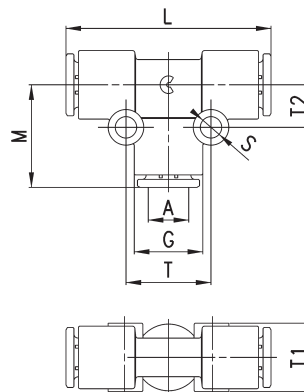

DIMENSIONES									
Mod.	A	G	L	M	S	T	T1	T2	Peso (g)
7540 4	4	9,2	33	16,5	4	13	9,2	6,5	6
7540 6	6	11,6	37	18,5	4	15	11,4	7,5	9
7540 8	8	13,9	41	20,5	4	17	13,7	8,5	14
7540 10	10	16,1	48	24	4	16	15,8	8	18
7540 12	12	20,2	56	28	4	19,2	9	9,6	30
7540 16	16	27	67	33,5	-	-	-	-	61 *

\* = modelo sin agujeros de fijación

### Racores Mod. 7545

Multi Te Reducido

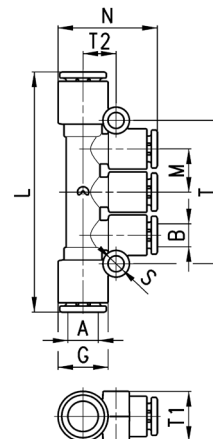

DIMENSIONES											
Mod.	A	B	G	L	M	N	S	T	T1	T2	Peso (g)
7545 6-4	6	4	11,6	55,5	9,6	23,5	4	32,5	11	7,5	12
7545 8-6	8	6	13,9	64	11,5	26,5	4	38,2	13,5	9	18
7545 10-8	10	8	16,1	78,5	14,1	30	4	45,8	16	10,5	27

### Racores Mod. 7560

Y Intermedio Reducido

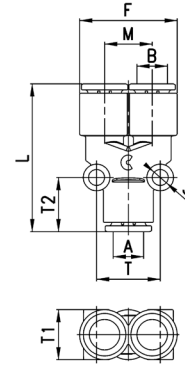

DIMENSIONES											
Mod.	A	B	F	L	M	S	T	T1	T2	Peso (g)	
7560 4	4	4	18,2	33	9	4	10,8	9,5	13	6	
7560 6	6	6	23	35	11,4	4	14,5	11,5	13,5	9	
7560 8	8	8	27,2	39,5	13,5	4	17	14	14,5	15	
7560 10	10	10	31,7	46	15,8	4	16,5	16	16,5	19	
7560 6-4	6	4	18,5	33,5	9	4	12,2	11,6	14,5	7	
7560 8-6	8	6	23	36	11,4	4	14,5	14	15,5	11	
7560 10-8	10	8	26,2	40	12,7	4	16,5	15,5	16	16	

### Racores Mod. 7575

Doble Y Reducido

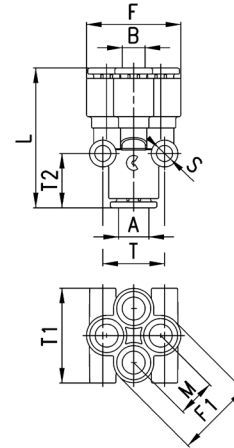

DIMENSIONES											
Mod.	A	B	F	F1	L	M	S	T	T1	T2	Peso (g)
7575 6-4	6	4	20,5	17	33,5	8,3	4	14,5	20,5	13,5	12
7575 8-6	8	6	25	21	37	10,2	4	16,5	25	14,5	17

### Racores Mod. 7950

Alargador de tecnopolímero

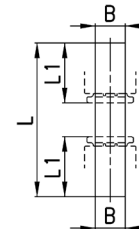

DIMENSIONES				
Mod.	B	L	L1	Peso (g)
7950 4	4	37	14	1
7950 6	6	39	15	1
7950 8	8	41	16	1
7950 10	10	44	18,5	1
7950 12	12	49	19	1

# Racores super-rápidos doble sujeción Serie 8000 en latón

Diámetros externos tubo: 4, 6, 8, 10 y 12 mm

Conexiones roscadas: cilíndricas (G1/8, G1/4, G3/8, G1/2)

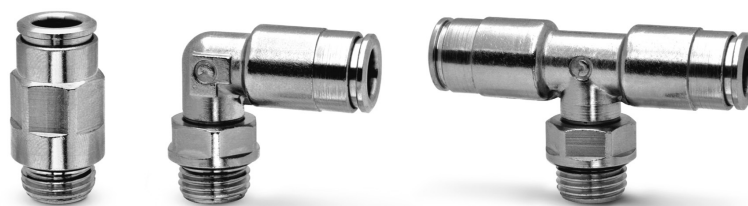

Con la gran experiencia de Camozzi en la fabricación de racores push-in en el campo neumático, y del estudio profundizado en la industria del fluido, nació la serie de racores super-rápidos de doble sujeción Serie 8000.

Esta nueva Serie 8000 deriva de la Serie 6000, ampliamente comprobada en el sector de la neumática.

Una junta adicional (sistema patentado), permite una doble sujeción sobre el tubo, garantizando una conexión muy fiable y evitando cualquier riesgo de pérdidas. Conexiones y desconexiones del tubo pueden ser repetidas muchas veces sin utilizar herramientas y sin perder las prestaciones del racor o que se varíe la sujeción del tubo.

Las juntas NBR son estándar y pueden ser reemplazadas con otras juntas disponibles en FKM y EPDM.

## CARACTERÍSTICAS GENERALES

Diámetros	Ø 4, 6, 8, 10, 12
Roscas	Gas cilíndrico ISO-228 (BSP)
Temperatura	-20°C ÷ 80°C
Tubo de conexión	Poliamida (PA) 6 - 11 - 12, PU, Polièster Hytrel
Fluido	Todo los fluidos compatibles con los materiales del racor y con los cuales necesitan un alto cierre, por ejemplo con el agua. Para otros fluidos consultar nuestros técnicos.
Materiales	cuerpo y pinza en latón niquelado, juntas en NBR
Presión de trabajo	min. - 0,9 - max. 60 bar. Los racores Serie 8000 resisten a una presión de 60 bar. Sin embargo, el tubo utilizado puede comprometer o limitar la presión de trabajo de forma considerable.

## Racor con tubo de conexión

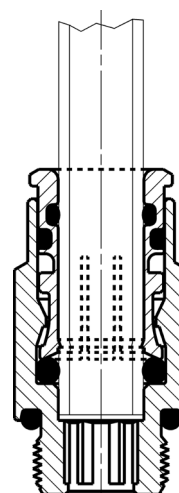

### Racores Mod. 8512

Recto Macho Cilíndrico

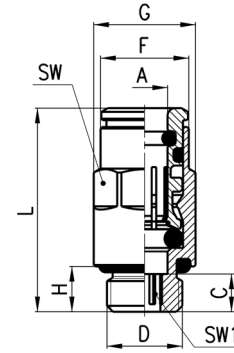

DIMENSIONES										
Mod.	A	D	C	F	G	H	L	SW	SW1	Peso (g)
8512 4-1/8	4	G1/8	5	8.8	13.5	6	23.8	12	2.5	14
8512 6-1/8	6	G1/8	5	11.7	13.5	6	27	12	4	15
8512 6-1/4	6	G1/4	6	11.7	16.4	7	28	15	4	25
8512 8-1/8	8	G1/8	8.5	13.7	15.2	6	32.5	14	5	20
8512 8-1/4	8	G1/4	7	13.7	16.4	7	31	15	6	24
8512 10-1/4	10	G1/4	10	16.3	18.5	7	36.5	17	7	32
8512 10-3/8	10	G3/8	4.5	16.3	20.5	7	31	19	8	38
8512 12-3/8	12	G3/8	4.6	18.4	20.5	7	30.5	19	9	30
8512 12-1/2	12	G1/2	5.6	18.4	24.8	8	31.5	22	9	50

### Racores Mod. 8522

Codo Giratorio Macho Cilíndrico

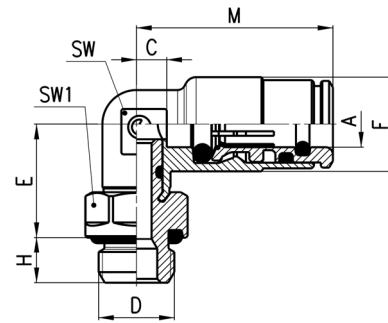

DIMENSIONES										
Mod.	A	D	C	E	F	H	M	SW	SW1	Peso (g)
8522 4-1/8	4	G1/8	3	14.5	10	6	21.5	9	12	18
8522 6-1/8	6	G1/8	4	15	12.5	6	26	10	12	23
8522 6-1/4	6	G1/4	4	16	12.5	7	26	10	15	30
8522 8-1/8	8	G1/8	5	16	14.5	6	29	12	12	28
8522 8-1/4	8	G1/4	5	17	14.5	7	29	12	15	34
8522 10-1/4	10	G1/4	5	19.5	16.8	7	31.5	13	15	40
8522 10-3/8	10	G3/8	5	19.5	16.8	7	31.5	13	19	50
8522 12-3/8	12	G3/8	7	20.5	19	7	33	15	19	55
8522 12-1/2	12	G1/2	7	21.5	19	8	33	15	22	68

### Racores Mod. 8432

Te Giratorio Macho Cilíndrico

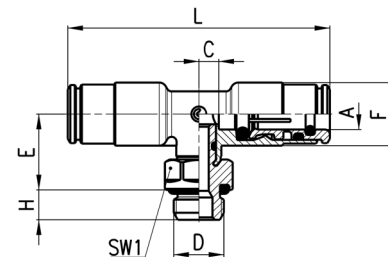

DIMENSIONES										
Mod.	A	D	C	E	F	H	L	SW1	Peso (g)	
8432 4-1/8	4	G1/8	3	14,5	10	6	43	12	25	
8432 6-1/8	6	G1/8	4	15	12,5	6	52	12	33	
8432 8-1/8	8	G1/8	5	16	14,5	6	58	12	42	
8432 8-1/4	8	G1/4	5	17	14,5	7	58	15	49	

**Racores Mod. 8580**



Recto Intermedio

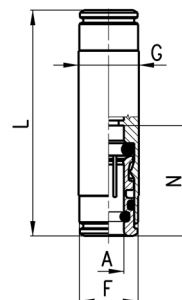

DIMENSIONES						
Mod.	A	F	G	L	N	Peso (g)
8580 4	4	8,8	10	38	19	16
8580 6	6	11,7	12	45	22	23
8580 8	8	-	14	48	24	30

**Racores Mod. 8540**



Te Intermedio

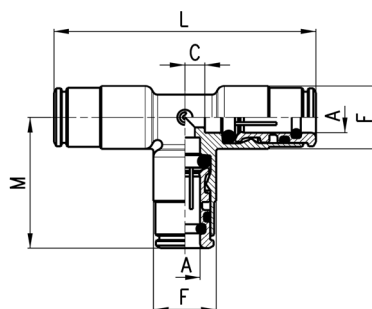

DIMENSIONES						
Mod.	A	C	F	M	L	Peso (g)
8540 4	4	3	10	21,5	43	22
8540 6	6	4	12,5	26	52	35
8540 8	8	5	14,5	29	58	49

**Racores Mod. 8550**



Codo Intermedio

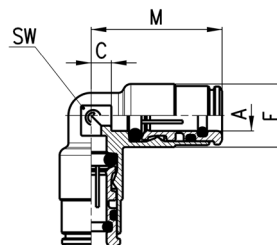

DIMENSIONES						
Mod.	A	C	F	M	SW	Peso (g)
8550 4	4	3	10	21,5	9	15
8550 6	6	4	12,5	26	10	25
8550 8	8	5	14,5	29	12	34

# Racores super-rápidos doble sujeción Serie H8000 en latón niquelado

Diámetros externos tubo: 4, 6, 8, 10, 12 mm  
Conexiones roscadas: cilíndricas (G1/8, G1/4, G3/8, G1/2)

RACORES SUPER-RÁPIDOS SERIE 8000



Los racores de la serie H8000 están diseñados para ser utilizados en entornos de trabajo especialmente sucios y polvorientos. El sello adicional patentado, garantiza una doble sujeción en el tubo, altamente confiable y evitando cualquier riesgo de fuga.

La forma especial del collar evita la entrada de impurezas dentro de la conexión, garantizando el rendimiento a lo largo del tiempo, la retención de el tubo y la facilidad de enganche y desenganche.

Los accesorios de la serie H8000 tienen un cuerpo de latón, sellos FKM para altas temperaturas (también disponibles en EPDM y NBR) y se pueden usar con presiones entre -0.9 y 60 bar.

- » Protección contra el polvo y los residuos.
- » Sin silicona
- » Adecuado para el vacío.
- » También es adecuado para tubos de metal.

## CARACTERÍSTICAS GENERALES

<b>Diámetros</b>	Ø 4, 6, 8, 10, 12 mm
<b>Roscas</b>	Gas cilíndrico ISO-228 (BSP)
<b>Temperatura</b>	Con juntas FKM (estándar): -15 ° C a 200 ° C (aire seco) Con juntas de EPDM (bajo pedido): -40 ° C a 110 ° C Con juntas NBR (bajo pedido): -20 ° C a 80 ° C
<b>Tubo de conexión</b>	Poliamida (PA) 6 - 11 - 12, PU, Polièster Hytrel, PTFE y tubos de metal (adecuadamente conformados).
<b>Fluido</b>	Todo los fluidos compatibles con los materiales del racor y con los cuales necesitan un alto cierre, por ejemplo con el agua. Para otros fluidos consultar nuestros técnicos.
<b>Materiales</b>	cuerpo: latón niquelado pinza: latón niquelado juntas: FKM (EPDM y NBR bajo pedido)
<b>Presión de trabajo</b>	min. - 0,9 - max. ÷ 60 bar. Los racores Serie H8000 resisten a una presión de 60 bar. Sin embargo, el tubo utilizado puede comprometer o limitar la presión de trabajo de forma considerable.

## Racor con tubo de conexión

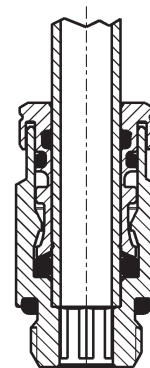

### Racores Mod. H8512

Recto Macho Cilíndrico

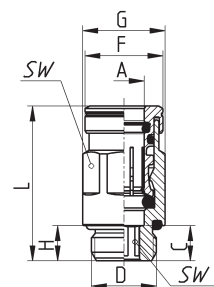

DIMENSIONES										
Mod.	A	D	C	F	G	H	L	SW	SW1	Peso (g)
H8512 4-1/8-V	4	G1/8	5	10.5	13.5	6	23.5	12	2.5	17
H8512 6-1/8-V	6	G1/8	5	13.5	13.5	6	27	12	4	18
H8512 6-1/4-V	6	G1/4	6	13.5	16.4	7	28	15	4	27.5
H8512 8-1/8-V	8	G1/8	8.5	15.5	16.4	6	32	15	6	23
H8512 8-1/4-V	8	G1/4	7	15.5	16.4	7	31	15	6	27
H8512 8-3/8-V	8	G3/8	5	15.5	20.5	7	29	15	6	42
H8512 10-1/8-V	10	G1/8	8.5	18	18.5	7	35	17	5	33.5
H8512 10-1/4-V	10	G1/4	10	18	18.5	7	36.5	17	7	35.5
H8512 10-3/8-V	10	G3/8	4.5	18	20.5	7	31	19	8	42
H8512 10-1/2-V	10	G1/2	4.5	18	24.8	8	31	22	8	63
H8512 12-1/4-V	12	G1/4	10.1	20	20.5	7	37	19	7	38.5
H8512 12-3/8-V	12	G3/8	4.6	20	20.5	7	32	19	9	35
H8512 12-1/2-V	12	G1/2	5.6	20	24.8	8	33	22	9	56

### Racores Mod. H8522

Codo Giratorio Macho Cilíndrico

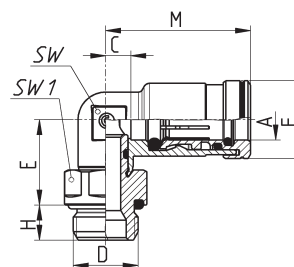

DIMENSIONES										
Mod.	A	D	C	E	F	H	M	SW	SW1	Peso (g)
H8522 4-1/8-V	4	G1/8	3	14.5	10.5	6	22	9	12	19.5
H8522 6-1/8-V	6	G1/8	4	15	13.5	6	26	10	12	25
H8522 6-1/4-V	6	G1/4	4	16	13.5	7	26	10	15	31.5
H8522 8-1/8-V	8	G1/8	5	16	15.5	6	29	12	12	30
H8522 8-1/4-V	8	G1/4	5	17	15.5	7	29	12	15	37.5
H8522 8-3/8-V	8	G3/8	5	17	15.5	7	29	12	19	47
H8522 10-1/8-V	10	G1/8	6	19.5	18	7	32.5	13	14	40
H8522 10-1/4-V	10	G1/4	5	19.5	18	7	32.5	13	15	44
H8522 10-3/8-V	10	G3/8	5	19.5	18	7	32.5	13	19	55
H8522 10-1/2-V	10	G1/2	6	19.5	18	8	32.5	13	22	66
H8522 12-1/4-V	12	G1/4	7	20.5	20	7	34	15	17	55
H8522 12-3/8-V	12	G3/8	7	20.5	20	7	34	15	19	60
H8522 12-1/2-V	12	G1/2	7	21.5	20	8	34	15	22	71

### Racores Mod. H8580



Recto Intermedio

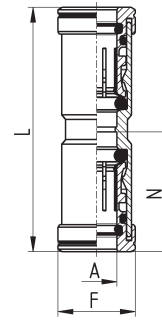

DIMENSIONES					
Mod.	A	F	N	L	Peso (g)
H8580 4-V	4	10.5	19	38	18.5
H8580 6-V	6	13.5	22	45	26.5
H8580 8-V	8	15.5	24	49	35
H8580 10-V	10	18	26.5	54	49.5
H8580 12-V	12	20	27	55	58

### Racores Mod. H8540



Te Intermedio

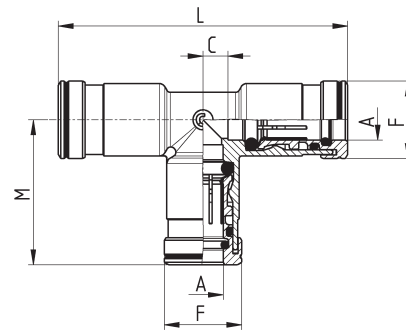

DIMENSIONES						
Mod.	A	C	F	M	L	Peso (g)
H8540 4-V	4	3	10.5	22	44	28
H8540 6-V	6	4	13.5	26	52	43
H8540 8-V	8	5	15.5	29	58	55
H8540 10-V	10	6	18	32.5	64	78
H8540 12-V	12	7	20	34	67	90

### Racores Mod. H8550



Codo Intermedio

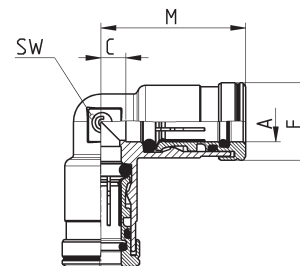

DIMENSIONES						
Mod.	A	C	F	M	SW	Peso (g)
H8550 4-V	4	3	10.5	22	9	20
H8550 6-V	6	4	13.5	26	10	30
H8550 8-V	8	5	15.5	29	12	40
H8550 10-V	10	6	18	32.5	-	54
H8550 12-V	12	7	20	34	-	64



# Racores super-rápidos Serie X6000 en Acero Inoxidable 316L

Diámetros externos tubo: 4, 6, 8, 10, 12 mm  
 Conexiones roscadas: cilíndricas [BSP] (G1/8, G1/4, G3/8, G1/2),  
 cónicas [BSPT] (R1/8, R1/4, R3/8, R1/2)

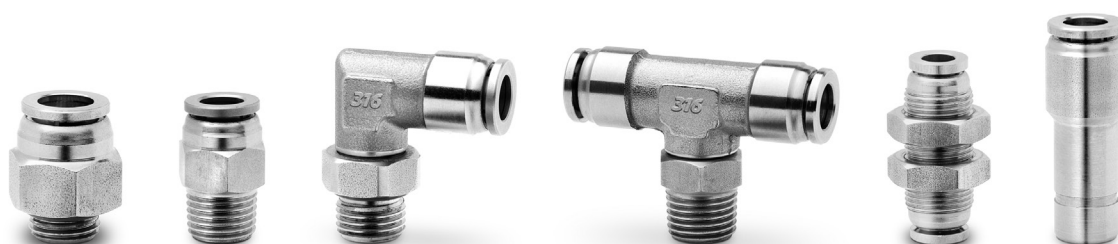

Los racores Serie X6000, diseñados para ofrecer flexibilidad y funcionalidad en la instalación sin renunciar a calidad y altas prestaciones, son adecuados para aplicaciones en sectores como Neumática, Fluidos, Químico, Farmacéutico, Alimentación y Embalaje.

Los racores Serie X6000, prácticos y seguros, permiten la realización de conexiones con fluidos incluso en condiciones particulares, como en el caso de ambientes agresivos. La pinza garantiza un excelente cierre entre el racor y el tubo.

## CARACTERÍSTICAS GENERALES

<b>Diámetros</b>	4 - 6 - 8 - 10 - 12 mm	
<b>Roscas</b>	GAS cónico ISO 7 (BSPT) GAS cilíndrico ISO 228 (BSP)	
<b>Temperatura</b>	-15°C ÷ 150°C NB: para un uso óptimo del accesorio, es aconsejable verificar las características de los tubos utilizados	
<b>Tubo de conexión</b>	PA 6-12, Rilsan PA11, Polietileno, PU, Poliester Hytrel	
<b>Fluido</b>	Aire comprimido y agua potable (para otro tipo de fluidos, contactar con nuestro departamento técnico)	
<b>Materiales</b>	1 = Cuerpo 2 = Juntas 3 = Anillo de sujeción 4 = Pinza de agarre 5 = Casquillo de bloqueo 6 = Casquillo de desbloqueo	Acero Inoxidable 316L FKM para alimentos Acero Inoxidable 316L Acero Inoxidable 301 Acero Inoxidable 316L Acero Inoxidable 316L
<b>Presión</b>	max 18 bar (ver tubos)	

## Racor con tubo de conexión

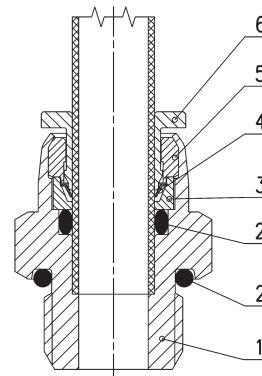

## Racores Mod. X6510

Recto Macho Cónico

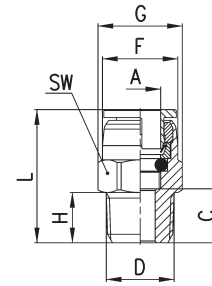

DIMENSIONES										
Mod.	A	C	D	F	G	H	L	SW	Peso (g)	Embalaje
X6510 4-1/8	4	8	R1/8	9.7	-	8	20.5	10	9	10
X6510 4-1/4	4	10	R1/4	9.7	-	10	22.5	14	15	10
X6510 6-1/8	6	8	R1/8	11.6	13.4	8	21.5	12	10	10
X6510 6-1/4	6	10	R1/4	11.6	15.2	10	23.5	14	17	10
X6510 8-1/8	8	8.5	R1/8	14.7	17	8	24.6	15	16	10
X6510 8-1/4	8	10	R1/4	14.7	17	10	26.1	15	20	10
X6510 10-1/4	10	11	R1/4	17.4	20.8	10	28.2	19	28	10
X6510 10-3/8	10	12	R3/8	17.4	20.8	11	29.2	19	35	10
X6510 10-1/2	10	14	R1/2	17.4	24.6	13	31.2	22	55	10
X6510 12-1/4	12	12	R1/4	20	-	10	31	22	42	10
X6510 12-3/8	12	12.5	R3/8	20	-	11	31.5	22	44	10
X6510 12-1/2	12	14.5	R1/2	20	-	13	33.5	22	59	10

## Racores Mod. X6512

Recto Macho Cilíndrico

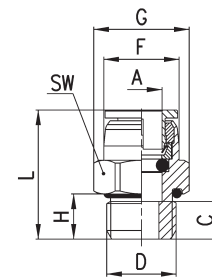

DIMENSIONES										
Mod.	A	C	D	F	G	H	L	SW	Peso (g)	Embalaje
X6512 4-1/8	4	5.7	G1/8	9.7	-	5.7	18.2	14	11	10
X6512 4-1/4	4	6.4	G1/4	9.7	-	6	18.9	17	18	10
X6512 6-1/8	6	6.7	G1/8	11.6	15	5.7	20.2	14	12	10
X6512 6-1/4	6	6.5	G1/4	11.6	-	6	20	17	19	10
X6512 8-1/8	8	8.7	G1/8	14.7	-	5.7	24.8	15	18	10
X6512 8-1/4	8	6	G1/4	14.7	-	6	22.1	17	21	10
X6512 10-1/4	10	8.5	G1/4	17.4	-	6	25.7	19	28	10
X6512 10-3/8	10	6.5	G3/8	17.4	-	6.5	23.7	22	29	10
X6512 10-1/2	10	11.5	G1/2	17.4	30	9.5	28.7	27	60	10
X6512 12-1/4	12	8.5	G1/4	20	-	6	27.5	22	40	10
X6512 12-3/8	12	9	G3/8	20	-	6.5	28	22	42	10
X6512 12-1/2	12	12.5	G1/2	20	30	9.5	31.5	27	71	10

**Racores Mod. X6500**

Codo Cónico Fijo

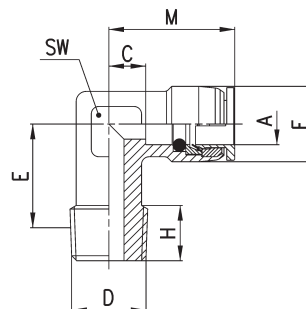

DIMENSIONES										
Mod.	A	C	D	E	F	H	M	SW	Peso (g)	Embalaje
X6500 4-1/8	4	7.8	R1/8	12.5	11	8	20.3	12	22	10
X6500 6-1/8	6	8.8	R1/8	12.5	11.9	8	22.3	12	20	10
X6500 6-1/4	6	8.8	R1/4	12	11.9	9	22.3	12	24	10
X6500 8-1/8	8	8.4	R1/8	15	15	8	24.5	12	26	10
X6500 8-1/4	8	8.4	R1/4	14	15	10	24.5	12	25	10
X6500 10-1/4	10	8.7	R1/4	15	17.4	10	25.9	14	36	10
X6500 10-3/8	10	8.7	R3/8	15	17.4	10.8	25.9	14	41	10
X6500 12-1/4	12	9.5	R1/4	16	20	10	28.5	17	49	10
X6500 12-3/8	12	9.5	R3/8	16	20	12	28.5	17	55	10

**Racores Mod. X6520**

Codo Cónico Giratorio

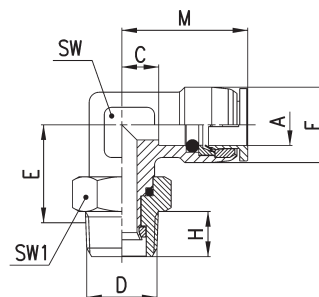

DIMENSIONES											
Mod.	A	C	D	E	F	H	M	SW	SW1	Peso (g)	Embalaje
X6520 4-1/8	4	4.3	R1/8	15.3	10	8	16.8	12	12	20	10
X6520 4-1/4	4	4.3	R1/4	15.8	10	10	16.8	12	15	24	10
X6520 6-1/8	6	8.8	R1/8	15.3	11.9	8	22.3	12	12	24	10
X6520 6-1/4	6	5.8	R1/4	19.8	13	10	19.3	14	15	33	10
X6520 8-1/8	8	9.4	R1/8	19.5	15	8	25.5	14	12	41	10
X6520 8-1/4	8	9.4	R1/4	19.8	15	10	25.5	14	15	44	10
X6520 10-1/4	10	10.7	R1/4	20.6	17.4	10	27.9	17	15	57	10
X6520 10-3/8	10	10.7	R3/8	20.9	17.4	11	27.9	17	19	65	10
X6520 12-1/4	12	9.5	R1/4	21.1	20	10	28.5	17	15	55	10
X6520 12-3/8	12	9.5	R3/8	20.9	20	11	28.5	17	19	65	10
X6520 12-1/2	12	9.5	R1/2	19.4	20	13	28.5	17	22	80	10

### Racores Mod. X6430

Te Cónico Central Giratorio

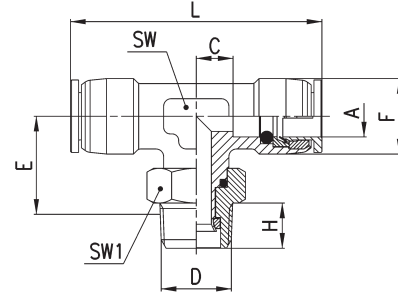

DIMENSIONES											
Mod.	A	C	D	E	F	H	L	SW	SW1	Peso (g)	Embalaje
X6430 4-1/8	4	4.3	R1/8	15.3	10	8	33.6	12	12	33	10
X6430 4-1/4	4	4.3	R1/4	15.8	10	10	33.6	12	15	41	10
X6430 6-1/8	6	8.8	R1/8	16.1	11.9	8	44.6	12	12	33	10
X6430 6-1/4	6	5.8	R1/4	18.6	13	10	38.6	14	15	45	10
X6430 8-1/8	8	8.3	R1/8	17.3	15	8	48.8	14	12	46	10
X6430 8-1/4	8	8.3	R1/4	18.5	15	10	48.8	14	15	54	10
X6430 10-1/4	10	10.7	R1/4	21.1	17.4	10	55.8	17	15	77	10
X6430 10-3/8	10	10.7	R3/8	20.9	17.4	11	55.8	17	19	84	10
X6430 12-1/4	12	9.5	R1/4	21.1	20	10	57	17	15	79	10
X6430 12-3/8	12	9.5	R3/8	20.9	20	11	57	17	19	87	10
X6430 12-1/2	12	15.6	R1/2	19.4	20	13	57	17	22	100	10

### Racores Mod. X6522

Codo Cilíndrico Giratorio

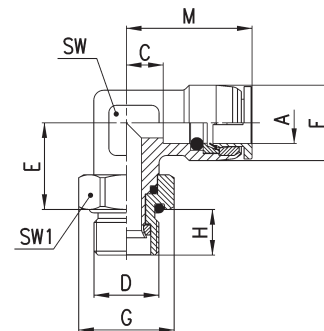

DIMENSIONES												
Mod.	A	C	D	E	F	G	H	M	SW	SW1	Peso (g)	Embalaje
X6522 4-1/8	4	4.3	G1/8	15.3	10	15	6.5	16.8	12	14	22	10
X6522 4-1/4	4	4.3	G1/4	15.7	10	18.5	9	16.8	12	17	25	10
X6522 6-1/8	6	8.8	G1/8	15.3	11.9	15	6.5	22.3	12	14	26	10
X6522 6-1/4	6	5.8	G1/4	18.7	13	18.5	9	19.3	14	17	40	10
X6522 8-1/8	8	9.4	G1/8	19.5	15	15	6.5	25.5	14	14	43	10
X6522 8-1/4	8	9.4	G1/4	18.7	15	18.5	9	25.5	14	17	46	10
X6522 10-1/4	10	10.7	G1/4	19.5	17.4	18.5	9	27.9	17	17	59	10
X6522 10-3/8	10	10.7	G3/8	20.4	17.4	24	9	27.9	17	22	72	10
X6522 12-1/4	12	9.5	G1/4	20	20	18.5	9	28.5	17	17	63	10
X6522 12-3/8	12	9.5	G3/8	20.4	20	24	9	28.5	17	22	73	10
X6522 12-1/2	12	9.5	G1/2	20.4	20	30	9.5	28.5	17	27	83	10

**Racores Mod. X6432**

Te Cilíndrico Central Giratorio

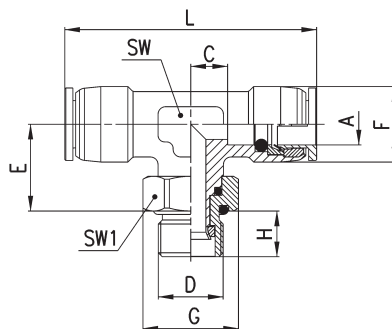

DIMENSIONES												
Mod.	A	C	D	E	F	G	H	L	SW	SW1	Peso (g)	Embalaje
X6432 4-1/8	4	4.3	G1/8	15.3	10	15	6.5	33.6	12	14	33	10
X6432 4-1/4	4	4.3	G1/4	15.7	10	18.5	9	33.6	12	17	46	10
X6432 6-1/8	6	8.8	G1/8	16.1	11.9	15	6.5	44.6	12	14	35	10
X6432 6-1/4	6	5.8	G1/4	17.5	13	18.5	9	38.6	14	17	47	10
X6432 8-1/8	8	8.3	G1/8	17.3	15	15	6.5	48.8	14	14	52	10
X6432 8-1/4	8	8.3	G1/4	17.4	15	18.5	9	48.8	14	17	57	10
X6432 10-1/4	10	10.7	G1/4	20	17.4	18.5	9	55.8	17	17	79	10
X6432 10-3/8	10	10.7	G3/8	20.4	17.4	24	9	55.8	17	22	91	10
X6432 12-1/4	12	9.5	G1/4	20	20	18.5	9	57	17	17	82	10
X6432 12-3/8	12	9.5	G3/8	20.4	20	24	9	57	17	22	94	10
X6432 12-1/2	12	9.5	G1/2	20.4	20	30	9.5	57	17	27	115	10

**Racores Mod. X6580**

Recto Intermedio

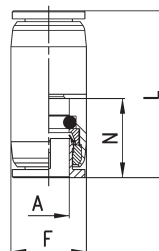
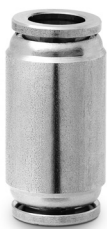

DIMENSIONES						
Mod.	A	F	L	N	Peso (g)	Embalaje
X6580 4	4	10	26.5	12.5	10	10
X6580 6	6	12	28.4	13.5	15	10
X6580 8	8	15	33.7	16.1	26	10
X6580 10	10	18	36.4	17.2	39	10
X6580 12	12	20	41	19	54	10

### Racores Mod. X6550

Codo Intermedio

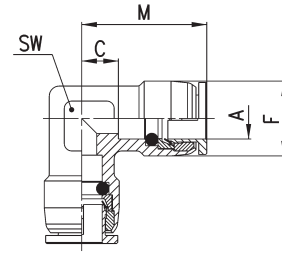

DIMENSIONES							
Mod.	A	C	F	M	SW	Peso (g)	Embalaje
X6550 4	4	7.8	11	20.3	12	22	10
X6550 6	6	8.8	11.9	22.3	12	23	10
X6550 8	8	8.4	15	24.5	12	28	10
X6550 10	10	8.7	17.4	25.9	14	42	10
X6550 12	12	9.5	20	28.5	17	58	10

### Racores Mod. X6540

Te Intermedio

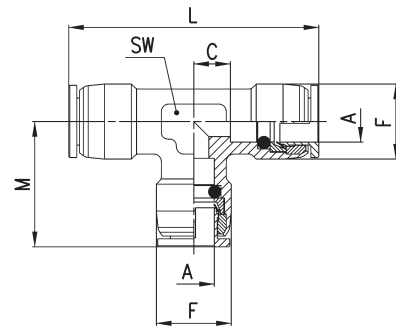

DIMENSIONES								
Mod.	A	C	F	L	M	SW	Peso (g)	Embalaje
X6540 4	4	8.8	11	42.6	21.3	12	32	10
X6540 6	6	8.8	11.9	44.6	22.3	12	33	10
X6540 8	8	8.4	15	49	24.5	12	44	10
X6540 10	10	8.7	17.4	51.8	25.9	14	54	10
X6540 12	12	9.5	20	57	28.5	17	80	10

### Racores Mod. X6590

Recto Intermedio Pasatabiques

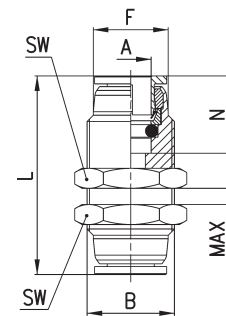

DIMENSIONES									
Mod.	A	B	F	L	N	MAX	SW	Peso (g)	Embalaje
X6590 4	4	M11X1	9.7	29	12.5	6	14	17	10
X6590 6	6	M13X1	11.6	34	13.5	9	17	29	10
X6590 8	8	M16X1	14.7	37.2	16.1	9	19	40	10
X6590 10	10	M19X1	17.4	43.4	17.2	11	22	62	10
X6590 12	12	M22X1	20	50	19	15	27	103	10

**Racores Mod. X6800**



Reducción Tubo-Espiga

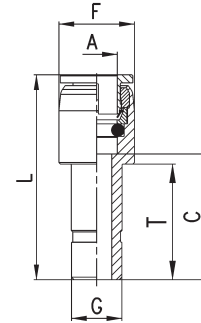

DIMENSIONES								
Mod.	A	C	F	G	L	T	Peso (g)	Embalaje
X6800 4-6	4	16.8	10	6	29.3	15.3	7	10
X6800 4-8	4	19.8	10	8	32.3	17.8	10	10
X6800 6-8	6	19.8	12	8	33.5	17.8	11	10
X6800 6-10	6	22.6	12	10	36	21.6	12	10
X6800 6-12	6	23	12	12	36.5	-	19	10
X6800 8-10	8	22.5	15	10	38.6	20	14	10
X6800 8-12	8	24.5	15	12	40.6	23	21	10
X6800 10-12	10	26	18	12	43.2	23	27	10

# Racores rápidos de cánula en latón Serie 1000 para tubos de plástico

Diámetros externos tubo: 5/3, 6/4, 8/6, 10/8, 12/10, 15/12,5 mm  
Conexiones roscadas: métricas (M5, M6, M12x1, M12x1,25),  
cilíndricas (G1/8, G1/4, G3/8, G1/2), cónicas (R1/8, R1/4, R3/8, R1/2)



Los racores rápidos Serie 1000 de cánula se pueden montar fácilmente.  
Las tuercas de bloqueo de la cánula se pueden apretar manualmente o con una llave, incluso con tubos rígidos de PA y Poliéster Hytrel.  
La especial forma del cono de conducción impide posibles cortes del tubo.

## CARACTERÍSTICAS GENERALES

<b>Diámetros</b>	5/3 - 6/4 - 8/6 - 10/8 - 12/10 - 15/12,5 mm
<b>Roscas</b>	GAS cónico ISO 7 (BSPT) GAS cilíndrico ISO 228 (BSP) M5- M6 NPT y métrica bajo pedido
<b>Temperatura</b>	-20°C ÷ 80°C NB: para un uso óptimo del accesorio, es aconsejable verificar las características de los tubos utilizados.
<b>Tubo de conexión</b>	PA polietilene, PVC trenzado, rilsan, PU, Poliester Hytrel
<b>Fluido</b>	aire comprimido y fluidos a baja presión
<b>Materiales</b>	cuerpo y tuerca OT niquelado, O-ring NBR, Juntas rosca PTFE/PA, AL
<b>Presión</b>	la presión nominal de los racores es siempre superior a la presión de utilización del tubo

## Racor con tubo de conexión

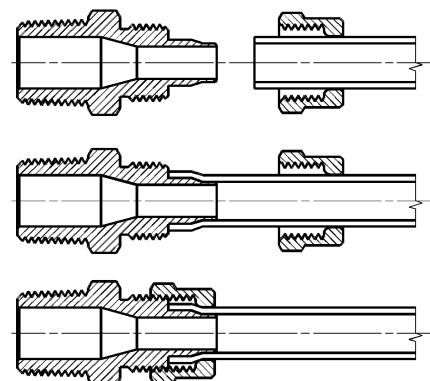



**Racores Mod. 1510**



Recto Macho Métrico-Cónico

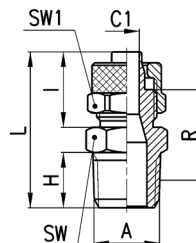

DIMENSIONES										
Mod.	Tubo	A	C1	H	I	L	R	SW	SW1	Peso (g)
1510 5/3-1/8	5/3	R1/8	2	7,5	12,5	24,5	14,5	12	8	10
1510 6/4-1/8	6/4	R1/8	3	7,5	15	27	16	12	12	15
1510 6/4-1/4	6/4	R1/4	3	11	15	31	18,5	14	12	19
1510 6/4-3/8	6/4	R3/8	3	11,5	15	31,5	18,5	17	12	22
1510 6/4-1/2	6/4	R1/2	3	14	15	34,5	20	22	12	38
1510 6/4-M12x1,25	6/4	M12X1,25	3	10	15	30	18	13	12	17
1510 8/6-1/8	8/6	R1/8	5	7,5	15	27	16	13	14	19
1510 8/6-1/4	8/6	R1/4	5	11	15	31	18,5	14	14	20
1510 8/6-3/8	8/6	R3/8	5	11,5	15	31,5	18,5	17	14	25
1510 8/6-1/2	8/6	R1/2	5	14	15	34,5	20	22	14	39
1510 10/8-1/8	10/8	R1/8	6,5	7,5	16,5	28,5	16,5	14	16	24
1510 10/8-1/4	10/8	R1/4	6,5	11	16,5	32,5	19	14	16	24
1510 10/8-3/8	10/8	R3/8	6,5	11,5	16,5	33	19	17	16	27
1510 10/8-1/2	10/8	R1/2	6,5	14	16,5	36	20,5	22	16	42
1510 12/10-3/8	12/10	R3/8	8,5	11,5	18	34,5	19	17	19	35
1510 12/10-1/2	12/10	R1/2	8,5	14	18	37,5	20,5	22	19	49
1510 15/12,5-1/2	15/12,5	R1/2	11	14	20	39,5	21	22	22	55

**Racores Mod. 1511**



Recto Macho Métrico Sprint®

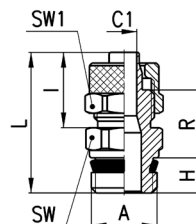

DIMENSIONES										
Mod.	Tubo	A	C1	H	I	L	R	SW	SW1	Peso (g)
1511 5/3-M5	5/3	M5	2	4	12,5	21	10,5	8	8	5 *
1511 5/3-M6	5/3	M6	2	4	12,5	21	10,5	9	8	5 *
1511 5/3-1/8	5/3	G1/8	2	5,5	12,5	23,8	11,8	12	8	10
1511 6/4-M5	6/4	M5	3	4	13,5	22	10,5	8	9	6 *
1511 6/4-M6	6/4	M6	3	4	13,5	22	10,5	9	9	7 *
1511 6/4-1/8	6/4	G1/8	3	5,5	15	26,3	13,3	12	12	15
1511 6/4-1/4	6/4	G1/4	3	7	15	28	13,5	14	12	16
1511 6/4-3/8	6/4	G3/8	3	8	15	29,3	13,8	19	12	27
1511 8/6-1/8	8/6	G1/8	5	5,5	15	26,3	13,3	12	14	17
1511 8/6-1/4	8/6	G1/4	5	7	15	28	13,5	14	14	18
1511 8/6-3/8	8/6	G3/8	5	8	15	29,3	13,8	19	14	27
1511 10/8-1/8	10/8	G1/8	6,5	5,5	16,5	27,8	13,8	14	16	23
1511 10/8-1/4	10/8	G1/4	6,5	7	16,5	29,5	14	14	16	25
1511 10/8-3/8	10/8	G3/8	6,5	8	16,5	30,8	14,3	19	16	30
1511 10/8-1/2	10/8	G1/2	6,5	9	16,5	32,5	15	22	16	36
1511 12/10-3/8	12/10	G3/8	8,5	8	18	32,3	14,3	19	19	39
1511 12/10-1/2	12/10	G1/2	8,5	9	18	34	15	22	19	42
1511 15/12,5-1/2	15/12,5	G1/2	11	9	20	36	15,5	22	22	52

\* = con O-Ring

### Racores Mod. 1560



Recto Macho Giratorio Sprint®

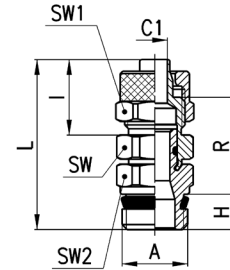

DIMENSIONES											
Mod.	Tubo	A	C1	H	I	L	R	SW	SW1	SW2	Peso (g)
1560 6/4-1/8	6/4	G1/8	3	5,5	15	31	18	12	12	12	19
1560 6/4-1/4	6/4	G1/4	3	7	15	32,5	18	12	12	14	25
1560 8/6-1/8	8/6	G1/8	5	5,5	15	32	19	13	14	12	21
1560 8/6-1/4	8/6	G1/4	5	7	15	33,5	19	13	14	14	26
1560 10/8-1/4	10/8	G1/4	6,5	7	16,5	34,5	19	14	16	14	27
1560 10/8-3/8	10/8	G3/8	6,5	8	16,5	36	19,5	14	16	19	38
1560 12/10-3/8	12/10	G3/8	6,5	8	18	38	20	17	19	19	46

### Racores Mod. 1463

Recto Hembra Cilíndrico

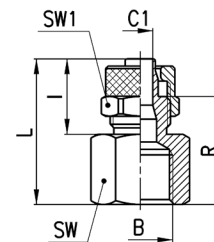

DIMENSIONES									
Mod.	Tubo	B	C1	I	L	R	SW	SW1	Peso (g)
1463 5/3-1/8	5/3	G1/8	2	12,5	22,5	16	13	8	10
1463 6/4-1/8	6/4	G1/8	3	15	25	17,5	13	12	14
1463 6/4-1/4	6/4	G1/4	3	15	26,5	19	17	12	21
1463 6/4-3/8	6/4	G3/8	3	15	27,5	20	20	12	25
1463 8/6-1/8	8/6	G1/8	5	15	25	17,5	13	14	16
1463 8/6-1/4	8/6	G1/4	5	15	26,5	19	17	14	22
1463 8/6-3/8	8/6	G3/8	5	15	27,5	20	20	14	26
1463 10/8-1/8	10/8	G1/8	6,5	16,5	21,5	13	14	16	19
1463 10/8-1/4	10/8	G1/4	6,5	16,5	28	19,5	17	16	28
1463 10/8-3/8	10/8	G3/8	6,5	16,5	29	20,5	20	16	31
1463 10/8-1/2	10/8	G1/2	6,5	16,5	33	24,5	24	16	43
1463 12/10-3/8	12/10	G3/8	8,5	18	30,5	20,5	20	19	37

**Racores Mod. 1541**

Codo Macho Giratorio Sprint®

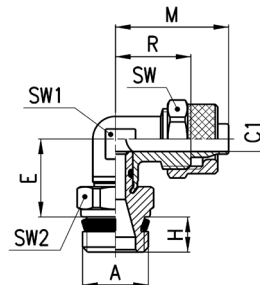

DIMENSIONES											
Mod.	Tubo	A	C1	E	H	M	R	SW	SW1	SW2	Peso (g)
1541 6/4-1/8	6/4	G1/8	3	15	5,5	22,5	15	12	10	12	22
1541 6/4-1/4	6/4	G1/4	3	15	7	22,5	15	12	10	14	27
1541 8/6-1/8	8/6	G1/8	5	15	5,5	22,5	15	14	10	12	23
1541 8/6-1/4	8/6	G1/4	5	15	7	22,5	15	14	10	14	28
1541 10/8-1/4	10/8	G1/4	6,5	16	7	25,5	17	16	12	14	35

**Racores Mod. 1500**

Codo Macho Fijo Métrico Cónico

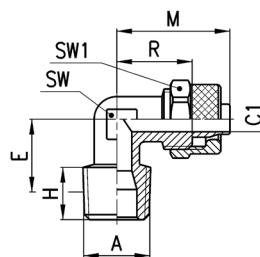

DIMENSIONES											
Mod.	Tubo	A	C1	E	H	M	R	SW	SW1	Peso (g)	
1500 5/3-1/8	5/3	R1/8	2	13	7,5	21,5	15	8	8	11	
1500 6/4-1/8	6/4	R1/8	3	13	7,5	22,5	15	8	12	15	
1500 6/4-1/4	6/4	R1/4	3	15,5	11	22,5	15	10	12	21	
1500 6/4-3/8	6/4	R3/8	3	17	11,5	23,5	16	12	12	27	
1500 6/4-M12x1,25	6/4	M12x1,25	3	14	10	22,5	15	10	12	18	
1500 8/6-1/8	8/6	R1/8	5	13	7,5	22,5	15	10	14	19	
1500 8/6-1/4	8/6	R1/4	5	15,5	11	22,5	15	10	14	21	
1500 8/6-3/8	8/6	R3/8	5	17	11,5	24	16	12	14	29	
1500 8/6-1/2	8/6	R1/2	5	21,5	14	27	19	16	14	48	
1500 10/8-1/8	10/8	R1/8	6,5	15	7,5	25,5	17	12	16	29	
1500 10/8-1/4	10/8	R1/4	6,5	17	11	25,5	17	12	16	29	
1500 10/8-3/8	10/8	R3/8	6,5	16,5	11,5	25,5	17	12	16	33	
1500 10/8-1/2	10/8	R1/2	6,5	21	14	28,5	20	16	16	58	
1500 12/10-3/8	12/10	R3/8	8,5	19	11,5	30	20	14	19	44	
1500 12/10-1/2	12/10	R1/2	8,5	21	14	30,5	20,5	16	19	59	
1500 15/12,5-1/2	15/12,5	R1/2	11	21	14	34	22,5	16	22	67	

### Racores Mod. 1501 5/3-M5

Codo Macho Fijo Métrico

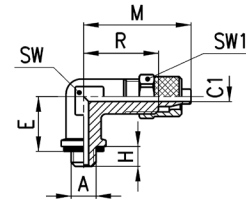

**DIMENSIONES**

Mod.	Tubo	A	C1	E	H	M	R	SW	SW1	Peso (g)
1501 5/3-M5	5/3	M5	2	11	4	21,5	15	8	8	10

### Racores Mod. 1493

Codo Hembra Cilíndrico

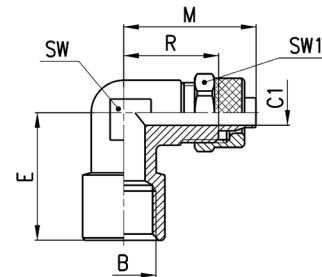

**DIMENSIONES**

Mod.	Tubo	B	C1	E	M	R	SW	SW1	Peso (g)
1493 6/4-1/8	6/4	G1/8	3	19	22,5	15	10	12	20
1493 6/4-1/4	6/4	G1/4	3	23,5	26	18,5	14	12	34
1493 8/6-1/8	8/6	G1/8	5	19	22,5	15	10	14	21
1493 8/6-1/4	8/6	G1/4	5	23,5	26	19	14	14	34
1493 10/8-1/4	10/8	G1/4	6,5	23,5	27,5	18	14	16	39
1493 12/10-3/8	12/10	G3/8	8,5	26	30,5	20,5	16	19	53

### Racores Mod. 1431

Te Macho Giratorio Sprint®

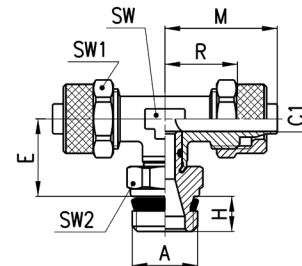

**DIMENSIONES**

Mod.	Tubo	A	C1	E	H	M	R	SW	SW1	SW2	Peso (g)
1431 6/4-1/8	6/4	G1/8	3	15	5,5	22,5	15	10	12	12	32
1431 6/4-1/4	6/4	G1/4	3	15	7	22,5	15	10	12	14	38
1431 8/6-1/8	8/6	G1/8	5	15	5,5	22,5	15	10	14	12	36
1431 8/6-1/4	8/6	G1/4	5	15	7	22,5	15	10	14	14	41
1431 10/8-1/4	10/8	G1/4	6,5	16	7	25,5	17	12	16	14	54

### Racores Mod. 1410

Te Macho Fijo Cónico

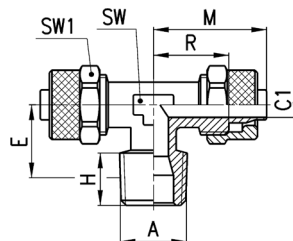

DIMENSIONES										
Mod.	Tubo	A	C1	E	H	M	R	SW	SW1	Peso (g)
1410 5/3-1/8	5/3	R1/8	2	12,5	7,5	21,5	15	8	8	16
1410 6/4-1/8	6/4	R1/8	3	12,5	7,5	22,5	15	8	12	25
1410 6/4-1/4	6/4	R1/4	3	15,5	11	22,5	15	10	12	32
1410 8/6-1/8	8/6	R1/8	5	13	7,5	22,5	15	10	14	31
1410 8/6-1/4	8/6	R1/4	5	15,5	11	22,5	15	10	14	35
1410 10/8-1/8	10/8	R1/8	6,5	15	7,5	25,5	17	12	16	47
1410 10/8-1/4	10/8	R1/4	6,5	17	11	25,5	17	12	16	50
1410 10/8-1/2	10/8	R1/2	6,5	21,5	14	28,5	20	16	16	80
1410 12/10-3/8	12/10	R3/8	8,5	19	11,5	30	20	14	19	77
1410 12/10-1/2	12/10	R1/2	8,5	21,5	14	30,5	20,5	16	19	92
1410 15/12,5-1/2	15/12,5	R1/2	11	21,5	14	34	22,5	16	22	107

### Racores Mod. 1420

Te Macho Lateral Cónico

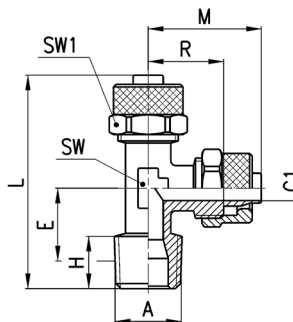

DIMENSIONES											
Mod.	Tubo	A	C1	E	H	L	M	R	SW	SW1	Peso (g)
1420 5/3-1/8	5/3	R1/8	2	12,5	7,5	37,5	21,5	15	8	8	15
1420 6/4-1/8	6/4	R1/8	3	12,5	7,5	38,5	22,5	15	8	12	23
1420 6/4-1/4	6/4	R1/4	3	15,5	11	43	22,5	15	10	12	29
1420 8/6-1/8	8/6	R1/8	5	13	7,5	39	22,5	15	10	14	31
1420 8/6-1/4	8/6	R1/4	5	15,5	11	43	22,5	15	10	14	34
1420 10/8-1/8	10/8	R1/8	6,5	15	7,5	43,5	25,5	17	12	16	46
1420 10/8-1/4	10/8	R1/4	6,5	17	11	47	25,5	17	12	16	50

## Racores Mod. 1610

### Anillo Individual

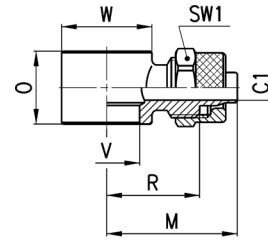

DIMENSIONES										
Mod.	Tubo	C1	M	O	R	V	W	SW1	Peso (g)	ensamblables con Mod.
1610 5/3-M5	5/3	2	17	9	10.5	5.1	Ø 9	8	8	1631, 1635
1610 5/3-M6	5/3	2	17	9	10.5	5.1	Ø 9	8	7	SCU, SVU, SCO...
1610 5/3-1/8	5/3	2	22.5	14.5	16	9.8	Ø 14	8	13	1631, 1635, SCU, SVU, SCO...
1610 6/4-M5	6/4	3	18	9	10.5	5.1	Ø 9	9	8	1631, 1635
1610 6/4-M6	6/4	2	18	9	10.5	5.1	Ø 9	9	8	SCU, SVU, SCO...
1610 6/4-1/8	6/4	3	24	14.5	16.5	9.8	Ø 14	12	18	1631, 1635, SCU, SVU, SCO...
1610 6/4-1/4	6/4	3	26	14.5	18.5	13.2	Ø 18	12	21	1631, 1635, SCU, SVU, SCO...
1610 6/4-3/8	6/4	3	28	14.5	20.5	16.7	Ø 21	12	22	1631, 1635, SCU, SVU, SCO...
1610 8/6-1/8	8/6	5	24	14.5	16.5	9.8	Ø 14	14	19	1631, 1635, SCU, SVU, SCO...
1610 8/6-1/4	8/6	5	26	14.5	18.5	13.2	Ø 18	14	22	1631, 1635, SCU, SVU, SCO...
1610 8/6-3/8	8/6	5	28	14.5	20.5	16.7	Ø 21	14	25	1631, 1635, SCU, SVU, SCO...
1610 10/8-1/8	10/8	6.5	25	14.5	16.5	9.8	Ø 14	16	25	1635, SCU, SVU, SCO...
1610 10/8-1/4	10/8	6.5	27	14.5	18.5	13.2	Ø 18	16	24	1635, SCU, SVU, SCO...
1610 10/8-3/8	10/8	6.5	29.5	14.5	21	16.7	Ø 21	16	28	1635, SCU, SVU, SCO...
1610 10/8-1/2	10/8	6.5	32	14.5	23.5	21	Ø 26	16	35	1635
1610 12/10-3/8	12/10	8	31.5	14.5	21.5	16.7	Ø 21	19	36	1635, SCU, SVU, SCO...
1610 12/10-1/2	12/10	8.5	33.5	14.5	23.5	21	Ø 26	19	40	1635
1610 15/12,5-1/2	15/12,5	11	36.5	14.5	25	21	Ø 26	22	48	1635

## Racores Mod. 1620

### Anillo Doble

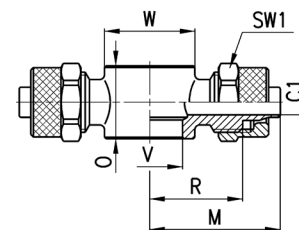

DIMENSIONES										
Mod.	Tubo	C1	M	O	R	V	W	SW1	Peso (g)	ensamblables con Mod.
1620 6/4-M5	6/4	3	18	9	10.5	5.1	Ø 9	9	12	1631, 1635
1620 6/4-1/8	6/4	3	24	14.5	16.5	9.8	Ø 14	12	29	1631, 1635, SCU, SVU, SCO...
1620 6/4-1/4	6/4	3	26	14.5	18.5	13.2	Ø 18	12	31	1631, 1635, SCU, SVU, SCO...
1620 8/6-1/8	8/6	5	24	14.5	16.5	9.8	Ø 14	14	31	1631, 1635, SCU, SVU, SCO...
1620 8/6-1/4	8/6	5	26	14.5	18.5	13.2	Ø 18	14	34	1631, 1635, SCU, SVU, SCO...

### Racores Mod. 1631 01

Banjo Individual



Se pueden ensamblar con racores giratorios  
Mod. 6610, 6620, 1610, 1620, 2023, 1170

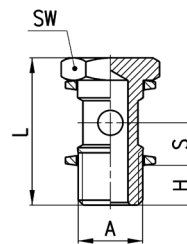

DIMENSIONES						
Mod.	A	H	L	S	SW	Peso (g)
1631 01-M5	M5	4	18	5,5	8	3 *
1631 01-1/8	G1/8	6	27	8,5	14	13
1631 01-1/4	G1/4	8	29,5	8,5	17	24
1631 01-3/8	G3/8	8	30	8,5	19	35
1631 01-1/2	G1/2	9	31	8,5	27	63

\* = acero zincado

### Racores Mod. 1635 01

Banjo Largo Individual



Se pueden ensamblar con racores giratorios  
Mod. 6610, 6620, 1610, 1620, 2023, 1170

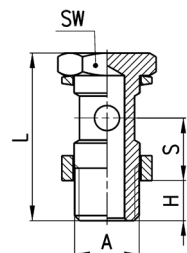

DIMENSIONES						
Mod.	A	H	L	S	SW	Peso (g)
1635 01-1/8	G1/8	6	31	12,5	14	15
1635 01-1/4	G1/4	8	33,5	12,5	17	27
1635 01-3/8	G3/8	8	34	12,5	19	37
1635 01-1/2	G1/2	9	35	12,5	27	71
1635 01-M12x1,25	M12x1,25	8	33,5	12,5	17	27 *
1635 01-M12x1,5	M12x1,5	8	33,5	12,5	17	27 *

\* = modelos ensamblables con racores orientables de 1/4

### Racores Mod. 1631 02

Banjo Doble



Se pueden ensamblar con racores giratorios  
Mod. 6610, 6620, 1610, 1620, 2023, 1170

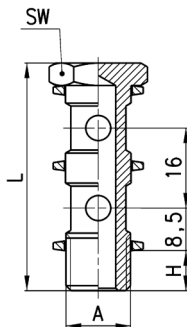

DIMENSIONES					
Mod.	A	H	L	SW	Peso (g)
1631 02-1/8	G1/8	6	43	14	18
1631 02-1/4	G1/4	8	45,5	17	33
1631 02-3/8	G3/8	8	46	19	48

### Racores Mod. 1635 02



Banjo Largo Doble

Se pueden ensamblar con racores giratorios  
Mod. 6610, 6620, 1610, 1620, 2023, 1170

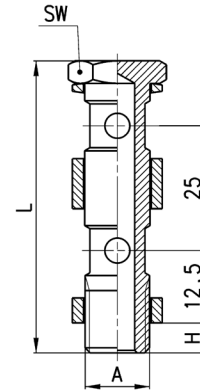

DIMENSIONES					
Mod.	A	H	L	SW	Peso (g)
1635 02-1/8	G1/8	6	56	14	26
1635 02-1/4	G1/4	8	58,5	17	33
1635 02-3/8	G3/8	8	59	19	64
1635 02-1/2	G1/2	9	60	27	111

### Racores Mod. 1631 03



Banjo Triple

Se pueden ensamblar con racores giratorios  
Mod. 6610, 6620, 1610, 1620, 2023, 1170

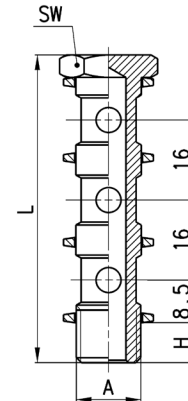

DIMENSIONES					
Mod.	A	H	L	SW	Peso (g)
1631 03-1/8	G1/8	6	59	14	24
1631 03-1/4	G1/4	8	61,5	17	42
1631 03-3/8	G3/8	8	62	19	62

### Racores Mod. 1580



Recto Intermedio

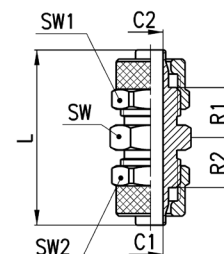

DIMENSIONES										
Mod.	Tubo	C1	C2	L	R1	R2	SW	SW1	SW2	Peso (g)
1580 5/3	5/3	2	2	28,5	7,5	7,5	8	8	8	8
1580 6/4	6/4	3	3	34,5	10	10	12	12	12	22
1580 8/6	8/6	5	5	34,5	9,75	9,75	13	14	14	28
1580 10/8	10/8	6,5	6,5	38	10,5	10,5	14	16	16	38
1580 12/10	12/10	8,5	8,5	41	10,5	10,5	17	19	19	55
1580 15/12,5	15/12,5	11	11	45	11	11	22	22	22	80
1580 8/6-6/4	8/6-6/4	5	3	34,5	9,75	9,75	13	12	14	24
1580 10/8-6/4	10/8-6/4	6,5	3	36,5	10,5	10	14	12	16	31



### Racores Mod. 1590



Pasamuros Recto - Reducido

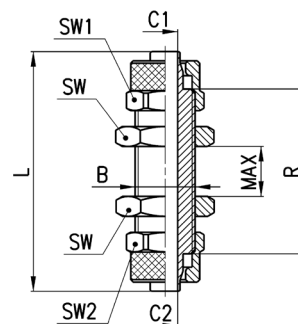

DIMENSIONES											
Mod.	Tubo	B	C1	C2	L	R	MAX	SW	SW1	SW2	Peso (g)
1590 5/3	5/3	M7x0,75	2	2	40	27	9	8	8	8	12
1590 6/4	6/4	M10x1	3	3	48	33	14	14	12	12	33
1590 8/6	8/6	M12x1	5	5	48	33	12	17	14	14	43
1590 10/8	10/8	M14x1	6,5	6,5	48	31	10	17	16	16	52
1590 12/10	12/10	M16x1	8,5	8,5	53	33	10	19	19	19	71
1590 6/4-5/3	6/4-5/3	M10x1	3	2	48	34	14	14	12	12	33
1590 8/6-6/4	8/6-6/4	M12x1	5	3	48	33	12	17	14	14	44

### Racores Mod. 1550



Codo Intermedio

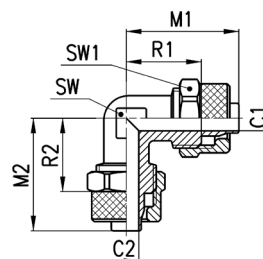

DIMENSIONES											
Mod.	Tubo	C1	C2	M1	M2	R1	R2	SW	SW1	SW2	Peso (g)
1550 6/4	6/4	3	3	22,5	22,5	15	15	8	12	12	21
1550 8/6	8/6	5	5	22,5	22,5	15	15	10	14	14	27
1550 10/8	10/8	6,5	6,5	25,5	25,5	17	17	12	16	16	40
1550 12/10	12/10	8,5	8,5	30	30	20	20	14	19	19	61
1550 15/12,5	15/12,5	11	11	34	34	22,5	22,5	16	22	22	88

### Racores Mod. 1540



Te Intermedio

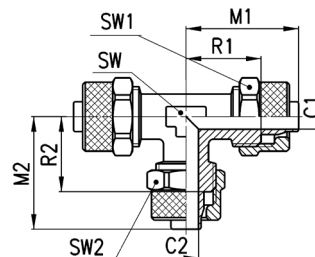

DIMENSIONES											
Mod.	Tubo	C1	C2	M1	M2	R1	R2	SW	SW1	SW2	Peso (g)
1540 5/3	5/3	2	2	21,5	21,5	15	15	8	8	8	17
1540 6/4	6/4	3	3	22,5	22,5	15	15	8	12	12	31
1540 8/6	8/6	5	5	22,5	22,5	15	15	10	14	14	39
1540 10/8	10/8	6,5	6,5	25,5	25,5	17	17	12	16	16	58
1540 12/10	12/10	8,5	8,5	30	30	20	20	14	19	19	90
1540 15/12,5	15/12,5	11	11	34	34	22,5	22,5	16	22	22	128
1540 8/6-6/4	8/6-6/4	5	3	22,5	22,5	15	15	10	14	12	38
1540 10/8-6/4	10/8-6/4	6,5	3	25,5	23,5	17	16,5	12	16	12	50
1540 10/8-8/6	10/8-8/6	6,5	5	25,5	24	17	16,5	12	16	14	53

### Racores Mod. 1600

Cruz Intermedia

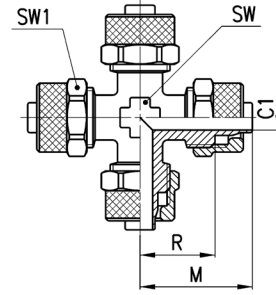

DIMENSIONES								
Mod.	Tubo	C1	M	R	SW	SW1	Peso (g)	
1600 6/4	6/4	3	22,5	15	8	12	41	
1600 8/6	8/6	5	22,5	15	10	14	52	

### Racores Mod. 1470

Adaptador con espiga

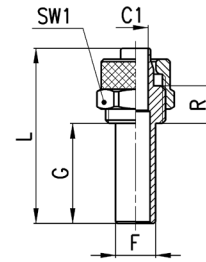

DIMENSIONES								
Mod.	Tubo	F	C1	G	L	R	SW1	Peso (g)
1470 6/4	6/4	6	3	20	35	7,5	12	11
1470 8/6	8/6	8	5	20	35	7,5	14	15

### Accesorios Mod. 2651

Anillo de cierre de aluminio

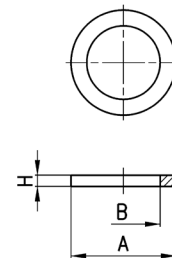

DIMENSIONES				
Mod.	A	B	H	Peso (g)
2651 1/8	14	9,8	1,5	1
2651 1/4	18	13,2	1,5	1
2651 3/8	22	16,7	1,5	1
2651 1/2	26	20,9	1,5	1
2651 1	38,5	33,4	1,5	2

**Accesorios Mod. 2661**

Anillo de cierre de plástico

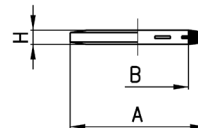

DIMENSIONES				
Mod.	A	B	H	Peso (g)
2661 M3	4,9	2,8	0,7	1
2661 M5	8	5,2	1	1
2661 M6	9	6,2	1	1
2661 1/8	14	10,2	1,9	1
2661 1/4	18	13,5	1,9	1
2661 3/8	21	16,5	2,1	1
2661 1/2	26	21,2	1,9	1

**Accesorios Mod. 2665**

Anillo de cierre de plástico

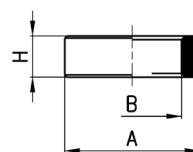

DIMENSIONES				
Mod.	A	B	H	Peso (g)
2665 1/8	14	9,8	5	1
2665 1/4	18	13,2	5	1
2665 3/8	21	16,8	5	1
2665 1/2	26	21,1	5	1

**Accesorios Mod. 2669**

Anillo de cierre largo de plástico

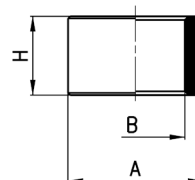
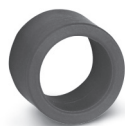

DIMENSIONES				
Mod.	A	B	H	Peso (g)
2669 1/8	14	9,8	10	1
2669 1/4	18	13,2	10	2
2669 3/8	21	16,8	10	2
2669 1/2	26	21,1	10	2

### Accesorios Mod. 1703

Tuerca de bloqueo

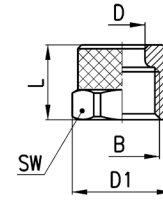

DIMENSIONES							
Mod.	Tubo	B	D	D1	L	SW1	Peso (g)
1703 5/3-M7x0,75	5/3	M7x0,75	5,1	8,8	8,5	8	1
1703 6/4-M8x0,75	6/4	M8x0,75	6,1	9,8	8,5	9	2
1703 6/4-M10x1	6/4	M10x1	6,1	13,3	10	12	4
1703 8/6-M12x1	8/6	M12x1	8,2	15,5	10	14	5
1703 10/8-M14x1	10/8	M14x1	10,15	17,5	13	16	8
1703 12/10-M16x1	12/10	M16x1	12,2	21	13,5	19	12
1703 15/12,5-M20x1	15/12,5	M20x1	15,2	24,5	16	22	15

### Accesorios Mod. 1723

Tuerca de bloqueo con Muelle de metal

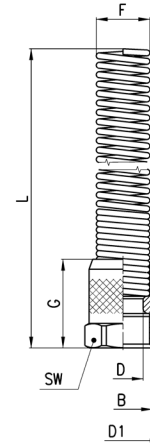

DIMENSIONES									
Mod.	Tubo	B	F	D	D1	G	L	SW	Peso (g)
1723 6/4-M10x1	6/4	M10x1	8,9	6,1	13,3	18	90,5	12	15
1723 8/6-M12x1	8/6	M12x1	10,9	8,2	15,5	18	94,5	14	23
1723 10/8-M14x1	10/8	M14x1	12,5	10,15	17,5	22	96,5	16	29
1723 12/10-M16x1	12/10	M16x1	15,5	12,2	21	23,5	108	19	46
1723 15/12,5-M20x1	15/12,5	M20x1	18,5	15,2	24,5	28	120	22	57

# Racores universales de ojiva Serie 1000 en latón

Para tubos en plástico, cobre, latón:  $\varnothing$  4, 6, 8, 10, 12 mm  
 Conexiones roscadas: cilíndricas (G1/8, G1/4),  
 cónicas (R1/8, R1/4, R3/8, R1/2)

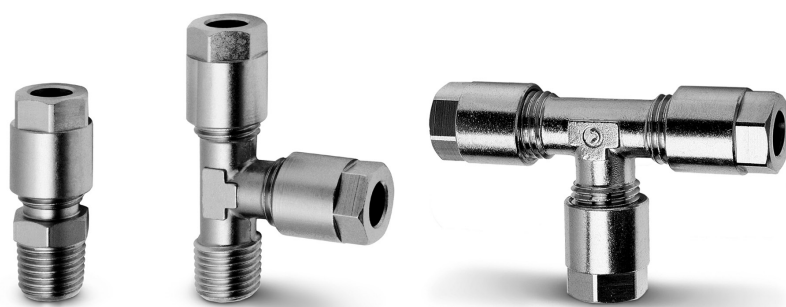

Los racores universales de ojiva Serie 1000 son utilizados con tubos de plástico de todo tipo y también con tubos de cobre, latón, acero y aluminio. Aptos para diversas aplicaciones, estos racores pueden ser empleados en circuitos neumáticos, oleodinámicos e hidráulicos a baja presión.

Los asientos de los racores, las ojivas y las tuercas están en conformidad con las normas DIN 3870-3861.

## CARACTERÍSTICAS GENERALES

<b>Diámetros</b>	4 - 6 - 8 - 10 - 12 mm
<b>Roscas</b>	GAS cónico ISO 7 (BSPT) GAS cilíndrico ISO 228 (BSP)
<b>Temperatura</b>	(ver características de los tubos utilizados)
<b>Tubo de conexión</b>	cobre recocido y tubos de plástico (con refuerzo)
<b>Fluido</b>	aire comprimido y fluidos a baja presión
<b>Materiales</b>	latón niquelado
<b>Presión</b>	presión máx 40 bar

## Racores con tubo de conexión

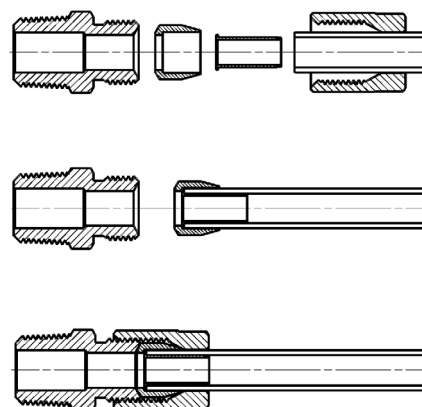

**Racores Mod. 1050**



Recto Macho Cónico

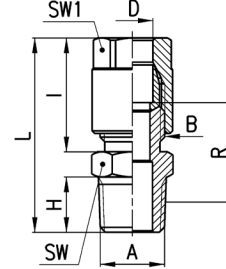

DIMENSIONES										
Mod.	D	A	B	H	I	L	R	SW	SW1	Peso (g)
1050 4-1/8	4	R1/8	1/8	7,5	19	31	14	12	12	19
1050 6-1/8	6	R1/8	1/8	7,5	19	31	14	12	12	18
1050 6-1/4	6	R1/4	1/8	11	19	35	16,5	14	12	23
1050 8-1/8	8	R1/8	1/4	7,5	23	35	15,5	14	14	29
1050 8-1/4	8	R1/4	1/4	11	23	39	18	14	14	33
1050 8-3/8	8	R3/8	1/4	11,5	23	39,5	18	17	14	40
1050 10-1/4	10	R1/4	3/8	11	25,5	41,5	18	17	17	51
1050 10-3/8	10	R3/8	3/8	11,5	25,5	42	18	17	17	55
1050 10-1/2	10	R1/2	3/8	14	25,5	45	18	22	17	65
1050 12-1/4	12	R1/4	M18x1,5	11	24,5	40,5	12	19	19	56 *
1050 12-3/8	12	R3/8	M18x1,5	11,5	24,5	41	12	19	19	58 *
1050 12-1/2	12	R1/2	M18x1,5	14	24,5	44	12	22	19	68 *

\* = con ojiva bicónica

**Racores Mod. 1063**



Recto Hembra Cilíndrico

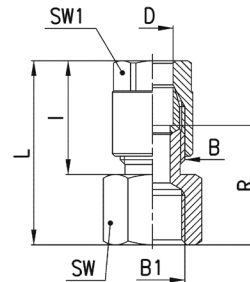

DIMENSIONES									
Mod.	D	B1	B	I	L	R	SW	SW1	Peso (g)
1063 4-1/8	4	G1/8	1/8	19	29	18,5	13	12	19
1063 6-1/8	6	G1/8	1/8	19	29	18,5	13	12	18
1063 6-1/4	6	G1/4	1/8	19	30,5	20	17	12	25
1063 8-1/8	8	G1/8	1/4	23	33	20	14	14	31
1063 8-1/4	8	G1/4	1/4	23	34,5	21,5	17	14	35

**Racores Mod. 1020**

Codo Macho Fijo Cónico

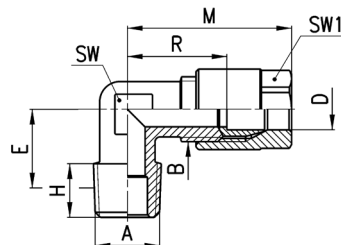

DIMENSIONES										
Mod.	D	A	B	E	H	M	R	SW	SW1	Peso (g)
1020 4-1/8	4	R1/8	1/8	11,5	7,5	29,5	19	9	12	21
1020 6-1/8	6	R1/8	1/8	11,5	7,5	29,5	19	9	12	19
1020 6-1/4	6	R1/4	1/8	13,5	11	29,5	19	12	12	27
1020 8-1/8	8	R1/8	1/4	11,5	7,5	33	20	11	14	35
1020 8-1/4	8	R1/4	1/4	13,5	11	33	20	12	14	36
1020 8-3/8	8	R3/8	1/4	15,5	11,5	35	22	14	14	50
1020 10-1/4	10	R1/4	3/8	15	11	38	22,5	13	17	59
1020 10-3/8	10	R3/8	3/8	15,5	11,5	38	22,5	14	17	58
1020 10-1/2	10	R1/2	3/8	16	14	38	22,5	16	17	78
1020 12-1/4	12	R1/4	M18x1,5	15	11	37	16,5	15	19	66 *
1020 12-3/8	12	R3/8	M18x1,5	15	11,5	37	16,5	15	19	66 *
1020 12-1/2	12	R1/2	M18x1,5	16	14	37	16,5	16	19	75 *

\* = con ojiva bicónica

**Racores Mod. 1093**

Codo Hembra Cilíndrico

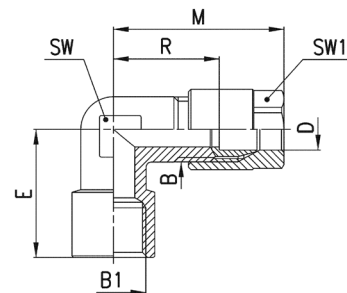

DIMENSIONES										
Mod.	D	B1	B	E	M	R	SW	SW1	Peso (g)	
1093 4-1/8	4	G1/8	1/8	19	29,5	18,5	12	12	31	
1093 6-1/8	6	G1/8	1/8	19	29,5	19	12	12	25	
1093 6-1/4	6	G1/4	1/8	23	30,5	20	13	12	39	
1093 8-1/8	8	G1/8	1/4	19	33	20	11	14	39	
1093 8-1/4	8	G1/4	1/4	23	35	22	13	14	44	

**Racores Mod. 1000**

Te Macho Fijo Cónico

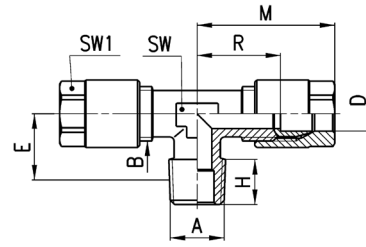

DIMENSIONES										
Mod.	D	A	B	E	H	M	R	SW	SW1	Peso (g)
1000 4-1/8	4	R1/8	1/8	11,5	7,5	29,5	19	9	12	35
1000 6-1/8	6	R1/8	1/8	11,5	7,5	29,5	19	9	12	33
1000 8-1/4	8	R1/4	1/4	13,5	11	33	20	12	14	63
1000 10-1/4	10	R1/4	3/8	15	11	38	22,5	13	17	104

**Racores Mod. 1010**

Te Macho Lateral Fijo Cónico

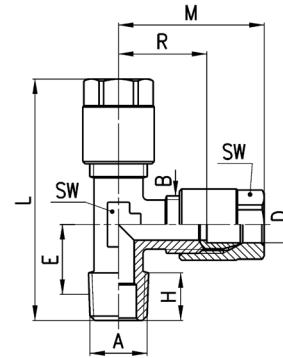

DIMENSIONES											
Mod.	D	A	B	E	H	L	M	R	SW	SW1	Peso (g)
1010 4-1/8	4	R1/8	1/8	11,5	7,5	48	29,5	19	9	12	37
1010 6-1/8	6	R1/8	1/8	11,5	7,5	48	29,5	19	9	12	33
1010 8-1/4	8	R1/4	1/4	13,5	11	54,5	33	20	12	14	61
1010 10-1/4	10	R1/4	3/8	15	11	61,5	38	22,5	13	17	103

**Racores Mod. 1230**

Recto Intermedio

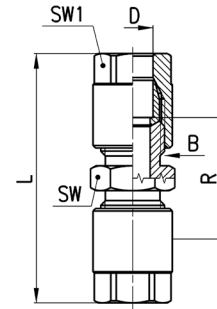

DIMENSIONES							
Mod.	D	B	L	R	SW	SW1	Peso (g)
1230 4	4	1/8	42,5	21,5	12	12	29
1230 6	6	1/8	42,5	21,5	12	12	26
1230 8	8	1/4	51	25	14	14	48
1230 10	10	3/8	56	25	17	17	83
1230 12	12	M18x1,5	54	13	19	19	140

\* = con ojiva bicónica

**Racores Mod. 1250**

Recto Pasamuros

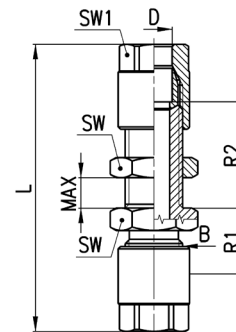

DIMENSIONES									
Mod.	D	B	L	R1	R2	MAX	SW	SW1	Peso (g)
1250 4	4	1/8	57,5	12,5	23	12	14	12	40
1250 6	6	1/8	57,5	13	23,5	12	14	12	38
1250 8	8	1/4	65	15	24	13	17	14	67
1250 10	10	3/8	72,5	15	26,5	13	22	17	119



### Racores Mod. 1220

Codo Intermedio

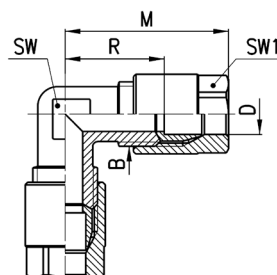

DIMENSIONES							
Mod.	D	B	M	R	SW	SW1	Peso (g)
1220 4	4	1/8	29,5	19	9	12	31
1220 6	6	1/8	29,5	19	9	12	29
1220 8	8	1/4	33	20	11	14	53
1220 10	10	3/8	38	22,5	14	17	92
1220 12	12	M18x1,5	37	16,5	16	19	99 *

\* = con ojiva bicónica

### Racores Mod. 1210

Te Intermedio

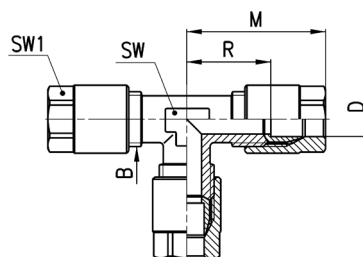

DIMENSIONES							
Mod.	D	B	M	R	SW	SW1	Peso (g)
1210 4	4	1/8	29,5	19	9	12	45
1210 6	6	1/8	29,5	19	9	12	42
1210 8	8	1/4	33	20	12	14	79
1210 10	10	3/8	38	22,5	13	17	133
1210 12	12	M18x1,5	37	16,5	16	19	144 *

\* = con ojiva bicónica

### Racores Mod. 1170

Anillo Individual

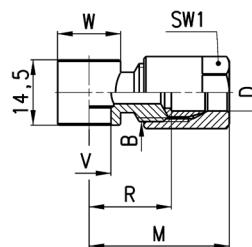

DIMENSIONES									
Mod.	D	B	R	M	V	W	SW1	Peso (g)	ensamblables con Mod.
1170 6-1/8	6	1/8	17.5	28	9.8	14	12	20	1631, 1635, SCU, SVU, SCO...
1170 6-1/4	6	1/8	20	30.5	13.2	18	12	24	1631, 1635, SCU, SVU, SCO...
1170 8-1/8	8	1/4	18	31	9.8	14	14	31	1635, SCU, SVU, SCO...

### Accesorios Mod. 1303

Tuerca de bloqueo

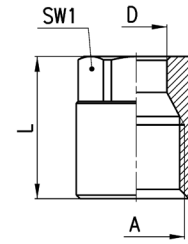

DIMENSIONES					
Mod.	D	A	L	SW1	Peso (g)
1303 4-1/8	4	1/8	15,5	12	8
1303 6-1/8	6	1/8	15,5	12	8
1303 8-1/4	8	1/4	19	14	14
1303 10-3/8	10	3/8	21,5	17	24
1303 12-M18x1,5	12	M18x1,5	19,5	19	27

### Accesorios Mod. 1310

Ojiva y Bicóno

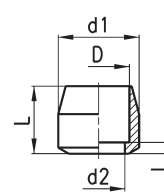

FIG. 1

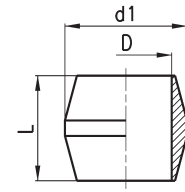

FIG. 2

DIMENSIONES						
Mod.	D	d1	d2	l	L	Peso (g)
1310 4	4	7,8	3	1	8	2
1310 6	6	7,8	4,5	1	7	1
1310 8	8	10,8	7	1,5	9	3
1310 10	10	13,8	9	1,5	11,5	5
1310 12-M18	12	16,3	12	-	11	6 *

Fig. 1 = ojiva

Fig. 2 = ojiva biconica

\* = con ojiva biconica

### Accesorios Mod. 1320

Insertos

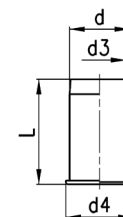

DIMENSIONES					
Mod.	d	d3	d4	L	Peso (g)
1320 4	4	3	5	12	1
1320 6	6	5	7	13	1
1320 8	8	7	9	14	1
1320 10	10	9	11	16	2

# Racores accesorios Sprint® Serie S2000 en latón

Conexiones roscadas: cilíndricas (G1/8, G1/4, G3/8, G1/2),  
cónicas (R1/8, R1/4, R3/8, R1/2)



Los racores accesorios Sprint® se caracterizan por la gran fiabilidad de las roscas hembras, cilíndricas y cónicas, con superficies no lisas.

Los modelos Sprint son dotados de un particular sistema de cierre, ya alojado en la rosca cónica, que sustituye al empleo de colas líquidas o de cinta de teflón (PTFE), optimizando la fase de montaje.

Este sistema de cierre permite montar y desmontar el racor varias veces sin perjudicar el cierre de su rosca.

## CARACTERÍSTICAS GENERALES

<b>Roscas</b>	GAS cónico ISO 7 ( BSPT ) GAS cilíndrico ISO 228 ( BSP )
<b>Temperatura</b>	-40°C ÷ 120°C
<b>Fluido</b>	aire comprimido y otros fluidos a baja presión
<b>Materiales</b>	latón niquelado y PTFE
<b>Presión</b>	80 bar

## Racores Accesorios Sprint®

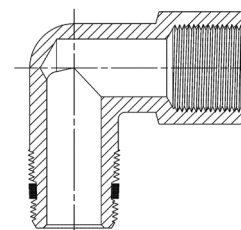

### Racores Mod. S2500



Niple Cónico Sprint®

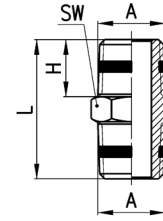

DIMENSIONES					
Mod.	A	H	L	SW	Peso (g)
S2500 1/8	R1/8	7,5	19,5	12	8
S2500 1/4	R1/4	11	27	14	15
S2500 3/8	R3/8	11,5	28	17	21
S2500 1/2	R1/2	14	33,5	22	39

### Racores Mod. S2510



Reducción Cónica Sprint®

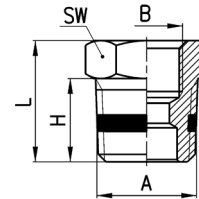

DIMENSIONES						
Mod.	A	B	H	L	SW	Peso (g)
S2530 1/4-1/8	R1/4	G1/8	11	16	14	9
S2530 3/8-1/8	R3/8	G1/8	11,5	16,5	17	16
S2530 1/2-1/8	R1/2	G1/8	14	19,5	22	13
S2530 3/8-1/4	R3/8	G1/4	11,5	16,5	17	33
S2530 1/2-1/4	R1/2	G1/4	14	19,5	22	32
S2530 1/2-3/8	R1/2	G3/8	14	19,5	22	22

### Racores Mod. S2520



Alargador Reducción Macho Cónica Sprint®

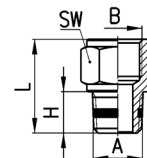

DIMENSIONES						
Mod.	A	B	H	L	SW	Peso (g)
S2520 1/8-1/8	R1/8	G1/8	7,5	17,5	13	11
S2520 1/8-1/4	R1/8	G1/4	7,5	19	17	15
S2520 1/8-3/8	R1/8	G3/8	7,5	20	20	19
S2520 1/4-1/4	R1/4	G1/4	11	22,5	17	17
S2520 1/4-3/8	R1/4	G3/8	11	23,5	20	33
S2520 1/4-1/2	R1/4	G1/2	11	27,5	24	34
S2520 3/8-3/8	R3/8	G3/8	11,5	24	20	36
S2520 3/8-1/2	R3/8	G1/2	11,5	28	24	56
S2520 1/2-1/2	R1/2	G1/2	14	30,5	24	41

**Racores Mod. S2510**



Reducción Cónica Sprint®

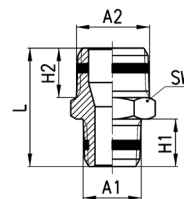

DIMENSIONES							
Mod.	A1	A2	H1	H2	L	SW	Peso (g)
S2510 1/8-1/4	R1/8	R1/4	7,5	11	23,5	14	14
S2510 1/8-3/8	R1/8	R3/8	7,5	11,5	24	17	22
S2510 1/4-3/8	R1/4	R3/8	11	11,5	27,5	17	19
S2510 1/4-1/2	R1/4	R1/2	11	14	30,5	22	33
S2510 3/8-1/2	R3/8	R1/2	11,5	14	31	22	36

**Racores Mod. 2541**



Niple Macho Giratorio Cilíndrico Sprint®

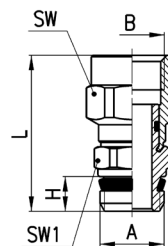

DIMENSIONES							
Mod.	A	B	H	L	SW	SW1	Peso (g)
2541 1/8-1/8	G1/8	G1/8	5,5	28	13	14	17
2541 1/4-1/4	G1/4	G1/4	7	31,5	17	14	26
2541 3/8-3/8	G3/8	G3/8	8	34	20	19	39

**Racores Mod. S2010**



Codo Macho Cónico Sprint®

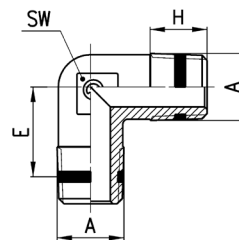

DIMENSIONES					
Mod.	A	E	H	SW	Peso (g)
S2010 1/8	R1/8	11,5	7,5	9	9
S2010 1/4	R1/4	13,5	11	12	17
S2010 3/8	R3/8	15,5	11,5	14	25
S2010 1/2	R1/2	16	14	16	47

**Racores Mod. S2020**



Codo Hembra Macho Sprint®

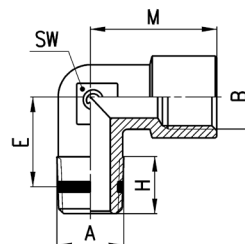

DIMENSIONES							
Mod.	A	B	E	H	M	SW	Peso (g)
S2020 1/8-1/8	R1/8	G1/8	11,5	8,5	19	11	16
S2020 1/4-1/4	R1/4	G1/4	15	11	23	13	27
S2020 3/8-3/8	R3/8	G3/8	15	11,5	25	15	33
S2020 1/2-1/2	R1/2	G1/2	17,5	14	31,5	20	62

### Racores Mod. S2050

T.M.M.F. Sprint®

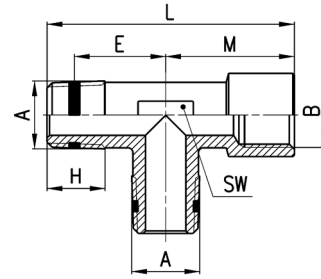

DIMENSIONES								
Mod.	A	B	E	H	L	M	SW	Peso (g)
S2050 1/8-1/8	R1/8	G1/8	11,5	8,5	37	19	12	14
S2050 1/4-1/4	R1/4	G1/4	15	11	46	23	13	44
S2050 3/8-3/8	R3/8	G3/8	15	11,5	48,5	25	16	59
S2050 1/2-1/2	R1/2	G1/2	17,5	14	60,5	31,5	20	81

### Racores Mod. S2060

T.F.M.F. Sprint®

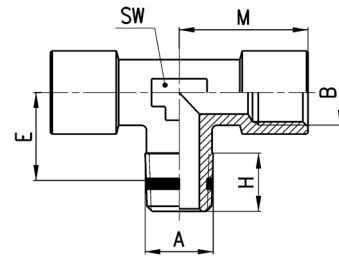

DIMENSIONES							
Mod.	A	B	E	H	M	SW	Peso (g)
S2060 1/8-1/8	R1/8	G1/8	11,5	8,5	19	12	31
S2060 1/4-1/4	R1/4	G1/4	15	11	23	13	38
S2060 3/8-3/8	R3/8	G3/8	15	11,5	25	16	51
S2060 1/2-1/2	R1/2	G1/2	17,5	14	31,5	20	88

### Racores Mod. S2070

T.M.F.F. Sprint®

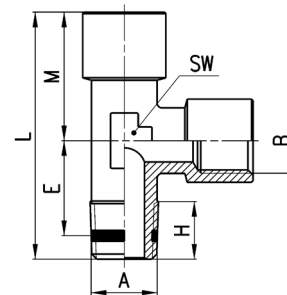

DIMENSIONES								
Mod.	A	B	E	H	L	M	SW	Peso (g)
S2070 1/8-1/8	R1/8	G1/8	11,5	8,5	37	19	12	30
S2070 1/4-1/4	R1/4	G1/4	15	11	46	23	13	36
S2070 3/8-3/8	R3/8	G3/8	15	11,5	48,5	25	16	51
S2070 1/2-1/2	R1/2	G1/2	17,5	14	60,5	31,5	20	89

### Racores Mod. S2080

Te Macho Sprint®

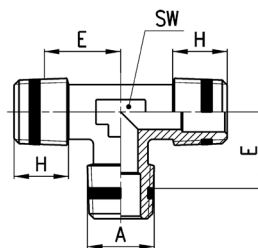

DIMENSIONES					
Mod.	A	E	H	SW	Peso (g)
S2080 1/8	R1/8	11,5	7,5	9	14
S2080 1/4	R1/4	13,5	11	12	31
S2080 3/8	R3/8	15,5	11,5	14	50
S2080 1/2	R1/2	16	14	16	63

### Racores Mod. S2090

T.M.F.M. Sprint®

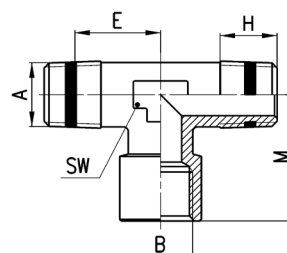

DIMENSIONES							
Mod.	A	B	E	H	M	SW	Peso (g)
S2090 1/8-1/8	R1/8	G1/8	11,5	8,5	19	12	22
S2090 1/4-1/4	R1/4	G1/4	15	11	23	13	16
S2090 3/8-3/8	R3/8	G3/8	15	11,5	25	16	59
S2090 1/2-1/2	R1/2	G1/2	17,5	14	31,5	20	80

### Racores Mod. 2612

Tapón Macho Cilíndrico

Nuevos modelos

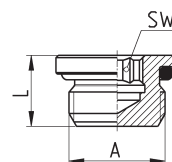

DIMENSIONES				
Mod.	A	L	SW	Peso (g)
2612 M5	M5	5.5	2	1
2612 M7	M7	7	4	2
2612 1/8	G1/8	8.5	4	5
2612 1/4	G1/4	9.5	6	9
2612 3/8	G3/8	10.5	8	17
2612 1/2	G1/2	11.5	12	25

### Racores Mod. S2610

Tapón Macho Cilíndrico Sprint®

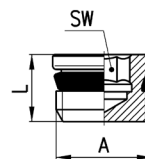

DIMENSIONES				
Mod.	A	L	SW	Peso (g)
S2610 1/8	G1/8	7.5	4	3
S2610 1/4	G1/4	9	6	6
S2610 3/8	G3/8	10	8	12
S2610 1/2	G1/2	11	10	21

**Racores Mod. S2615**



Tapón Macho retráctil  
Cónico Sprint®

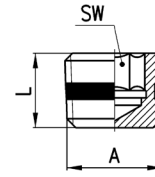

DIMENSIONES				
Mod.	A	L	SW	Peso (g)
S2615 1/8	R1/8	8	5	2
S2615 1/4	R1/4	10	7	6
S2615 3/8	R3/8	10	8	12

RACORES ACCESORIOS SPRINT® SERIE S2000



# Racores accesorios Serie 2000 en latón

Conexiones roscadas: métricas (M5), cilíndricas (G1/8, G1/4, G3/8, G1/2, G3/4, G1), cónicas (R1/8, R1/4, R3/8, R1/2, R3/4, R1)



La amplia gama de racores Serie 2000 incluye unión recta, codo, en T, en cruz, macho o hembra y garantiza el soporte necesario al diseño de sistemas de aire comprimido.

## CARACTERÍSTICAS GENERALES

<b>Roscas</b>	GAS cónico ISO 7 ( BSPT ) GAS cilíndrico ISO 228 ( BSP )
<b>Temperatura</b>	-40°C ÷ 120°C
<b>Fluido</b>	Aire comprimido y otros fluidos a baja presión
<b>Material</b>	latón niquelado
<b>Presión</b>	80 bar

## Racores accesorios

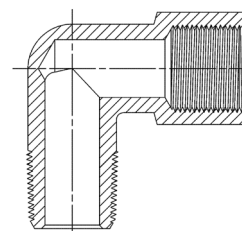

### Racores Mod. 2500



Niple Cónico

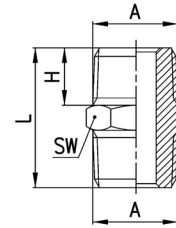

DIMENSIONES					
Mod.	A	H	L	SW	Peso (g)
2500 1/8	R1/8	7,5	19,5	12	9
2500 1/4	R1/4	11	27	14	16
2500 3/8	R3/8	11,5	28	17	21
2500 1/2	R1/2	14	33,5	22	41
2500 3/4	R3/4	16,5	40	27	80
2500 1	R1	19	45,5	34	125

### Racores Mod. 2501



Niple Métrico-BSP Cilíndrico

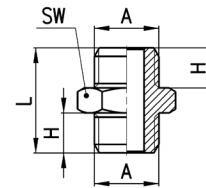

DIMENSIONES					
Mod.	A	H	L	SW	Peso (g)
2501 M5	M5	4	11,5	8	2
2501 1/8	G1/8	6	16,5	13	9
2501 1/4	G1/4	8	21	17	15
2501 3/8	G3/8	9	23	19	21
2501 1/2	G1/2	10	25,5	24	35

### Racores Mod. 2510



Niple Reducido Cónico

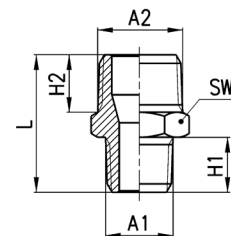

DIMENSIONES							
Mod.	A1	A2	H2	H1	L	SW	Peso (g)
2510 1/8-1/4	R1/8	R1/4	11	7,5	23,5	14	14
2510 1/8-3/8	R1/8	R3/8	11,5	7,5	24	17	18
2510 1/4-3/8	R1/4	R3/8	11,5	11	27,5	17	20
2510 1/4-1/2	R1/4	R1/2	14	11	30,5	22	34
2510 3/8-1/2	R3/8	R1/2	14	11,5	31	22	34
2510 1/2-3/4	R1/2	R3/4	16,5	14	37,5	27	67

**Racores Mod. 2520**

Alargador Reducción Macho Cónica

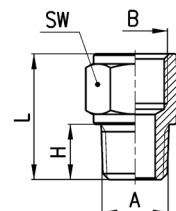

DIMENSIONES						
Mod.	A	B	H	L	SW	Peso (g)
2520 1/8-1/8	R1/8	G1/8	7,5	17,5	13	9
2520 1/8-1/4	R1/8	G1/4	7,5	19	17	15
2520 1/8-3/8	R1/8	G3/8	7,5	20	20	19
2520 1/4-1/4	R1/4	G1/4	11	22,5	17	17
2520 1/4-3/8	R1/4	G3/8	11	23,5	20	21
2520 1/4-1/2	R1/4	G1/2	11	27,5	24	35
2520 3/8-3/8	R3/8	G3/8	11,5	24	20	23
2520 3/8-1/2	R3/8	G1/2	11,5	28	24	37
2520 1/2-1/2	R1/2	G1/2	14	30,5	24	41

**Racores Mod. 2521**

Alargador Reducción Métrico-BSP Cilíndrico

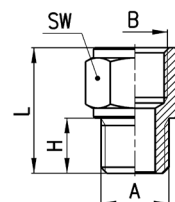

DIMENSIONES						
Mod.	A	B	H	L	SW	Peso (g)
2521 M5-1/8	M5	G1/8	4	14	13	7
2521 1/8-1/8	G1/8	G1/8	6	16	13	8
2521 1/8-1/4	G1/8	G1/4	6	17,5	17	14
2521 1/8-3/8	G1/8	G3/8	6	18,5	20	30
2521 1/4-1/4	G1/4	G1/4	8	19,5	17	16
2521 1/4-3/8	G1/4	G3/8	8	20,5	20	20
2521 1/4-1/2	G1/4	G1/2	8	24,5	24	33
2521 3/8-3/8	G3/8	G3/8	9	21,5	20	22
2521 3/8-1/2	G3/8	G1/2	9	25,5	24	35
2521 1/2-1/2	G1/2	G1/2	10	26,5	24	36

### Racores Mod. 2511

Niple Reducido Métrico-BSP Cilíndrico

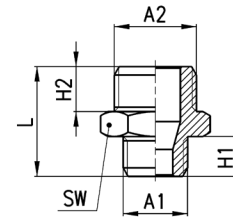

DIMENSIONES							
Mod.	A1	A2	H1	H2	L	SW	Peso (g)
2511 M5-1/8	M5	G1/8	4	6	14,5	13	8
2511 1/8-1/4	G1/8	G1/4	6	8	19	17	15
2511 1/8-3/8	G1/8	G3/8	6	9	20	19	19
2511 1/4-3/8	G1/4	G3/8	8	9	22	19	20
2511 1/4-1/2	G1/4	G1/2	8	10	23,5	24	32
2511 3/8-1/2	G3/8	G1/2	9	10	24,5	24	34

### Racores Mod. 2525

Alargador Macho Cilíndrico

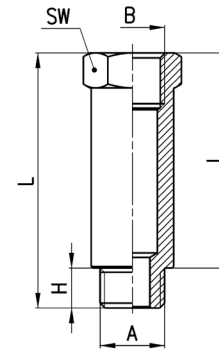

DIMENSIONES							
Mod.	A	B	H	I	L	SW	Peso (g)
2525 1/8-16	G1/8	G1/8	6	16	22	13	12
2525 1/8-36	G1/8	G1/8	6	36	42	13	24
2525 1/4-27	G1/4	G1/4	8	27	35	17	30
2525 1/4-43	G1/4	G1/4	8	43	51	17	45

### Racores Mod. 2530

Reducción Cónica

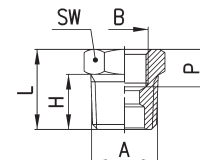

DIMENSIONES							
Mod.	A	B	H	P (min)	L	SW	Peso (g)
2530 1/4-1/8	R1/4	G1/8	11	6	16	14	9
2530 3/8-1/8	R3/8	G1/8	11,5	8,5	16,5	17	17
2530 1/2-1/8	R1/2	G1/8	14	9,5	19,5	22	12
2530 3/8-1/4	R3/8	G1/4	11,5	7	16,5	17	34
2530 1/2-1/4	R1/2	G1/4	14	9,5	19,5	22	30
2530 1/2-3/8	R1/2	G3/8	14	8	19,5	22	24
2530 3/4-3/8	R3/4	G3/8	16,5	11,5	23	27	67
2530 3/4-1/2	R3/4	G1/2	16,5	9,5	23,5	27	48
2530 1-1/2	R1	G1/2	19	14	27	34	131

**Racores Mod. 2531**

Reducción Cilíndrica

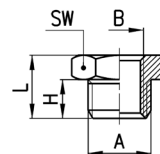

DIMENSIONES							
Mod.	A	B	H	L	SW	Peso (g)	
2531 1/8-M5	G1/8	M5	6	10,5	13	8	*
2531 1/4-1/8	G1/4	G1/8	8	13	17	11	*
2531 3/8-1/8	G3/8	G1/8	9	14	19	17	
2531 3/8-1/4	G3/8	G1/4	9	14	19	12	*
2531 1/2-1/8	G1/2	G1/8	10	15,5	24	32	
2531 1/2-1/4	G1/2	G1/4	10	15,5	24	29	
2531 1/2-3/8	G1/2	G3/8	10	15,5	24	22	*

\* = con roscada pasante

**Racores Mod. 2543**

Manguito

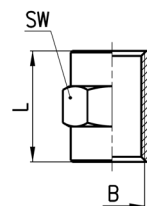

DIMENSIONES				
Mod.	B	L	SW	Peso (g)
2543 M5	M5	11	8	3
2543 1/8	G1/8	15	13	8
2543 1/4	G1/4	22	17	19
2543 3/8	G3/8	23	20	19
2543 1/2	G1/2	28	24	29

**Racores Mod. 2553**

Manguito Reducción

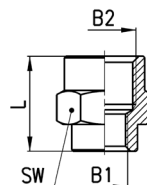

DIMENSIONES					
Mod.	B1	B2	L	SW	Peso (g)
2553 M5-1/8	M5	G1/8	13,5	13	7
2553 1/8-1/4	G1/8	G1/4	17	17	18
2553 1/8-3/8	G1/8	G3/8	18	20	18
2553 1/8-1/2	G1/8	G1/2	21,5	24	28
2553 1/4-3/8	G1/4	G3/8	21,5	20	21
2553 1/4-1/2	G1/4	G1/2	23	24	32
2553 3/8-1/2	G3/8	G1/2	24	24	31

### Racores Mod. 2611

Tapón Macho Cilíndrico

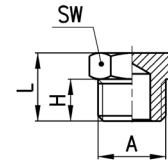

DIMENSIONES					
Mod.	A	H	L	SW	Peso (g)
2611 M5	M5	4	7,5	8	2
2611 1/8	G1/8	6	10,5	13	7
2611 1/4	G1/4	8	13	17	13
2611 3/8	G3/8	9	14	19	18
2611 1/2	G1/2	10	15,5	24	31
2611 1	G1	13	19	38	76

### Racor Mod. 2610 3/4

Tapón Macho Cónico

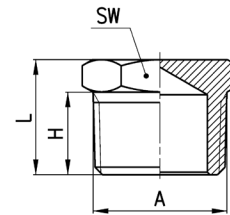

DIMENSIONES					
Mod.	A	H	L	SW	Peso (g)
2610 3/4	R3/4	16,5	23	27	61

### Racores Mod. 2613

Tapón Hembra Cilíndrico

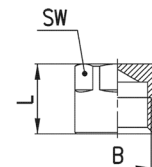

DIMENSIONES				
Mod.	B	L	SW	Peso (g)
2613 1/8	G1/8	11	12	6
2613 1/4	G1/4	13,5	15	13
2613 3/8	G3/8	15,5	18	19
2613 1/2	G1/2	22,5	19	33

**Racores Mod. 2601**



Manguera macho  
Métricas-cilíndricos

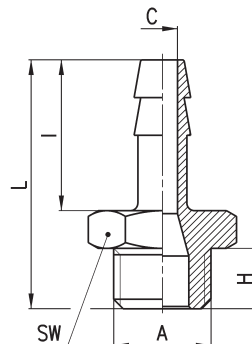

DIMENSIONES								
Mod.	N	A	C	H	I	L	SW	Peso (g)
2601 2-M5	2	M5	1,2	4	8	16	8	2
2601 4,5-M5	4	M5	2,5	4	15	23	8	3
2601 7-1/8	7	G1/8	4	6	20	30	12	9
2601 7-1/4	7	G1/4	4	8	20	33	17	16
2601 8-1/8	8	G1/8	5	6	20	30	12	10
2601 9-1/8	9	G1/8	5,5	6	20	30	12	11
2601 9-1/4	9	G1/4	6	8	20	33	17	17
2601 9-3/8	9	G3/8	6	9	20	34	19	21
2601 12-1/4	12	G1/4	8,5	8	20	33	17	20
2601 12-3/8	12	G3/8	9	9	20	34	19	23
2601 12-1/2	12	G1/2	9	10	20	35,5	24	34
2601 17-3/8	17	G3/8	12	9	24	38	19	31
2601 17-1/2	17	G1/2	13	10	24	39,5	24	41

**Racores Mod. 2013**

Codo Hembra Cilíndrico

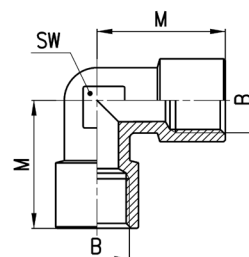

DIMENSIONES				
Mod.	B	M	SW	Peso (g)
2013 1/8	G1/8	19	11	16
2013 1/4	G1/4	23	14	28
2013 3/8	G3/8	25	16	39
2013 1/2	G1/2	31,5	20	69

### Racores Mod. 2010

Codo Macho Hembra Cónico

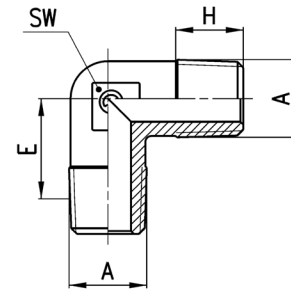

DIMENSIONES					
Mod.	A	E	H	SW	Peso (g)
2010 1/8	R1/8	11,5	7,5	9	10
2010 1/4	R1/4	13,5	11	12	18
2010 3/8	R3/8	15,5	11,5	14	28
2010 1/2	R1/2	16	14	16	47
2010 3/4	R3/4	19	16	25	103
2010 1	R1	23	17	30	183

### Racores Mod. 2021 y Mod. 2020

Mod. 2021: Codo Macho Hembra Métrico  
Mod. 2020: Codo Macho Hembra Cónico

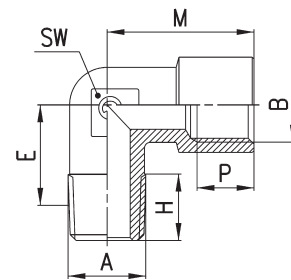

DIMENSIONES								
Mod.	A	B	E	H	M	P (min)	SW	Peso (g)
2021 M5-M5	M5	M5	9	4	10,5	4,5	9	7
2020 1/8-1/8	R1/8	G1/8	11,5	8,5	19	6	11	17
2020 1/4-1/4	R1/4	G1/4	15	11	23	7	13	27
2020 3/8-3/8	R3/8	G3/8	15	11,5	25	8	15	33
2020 1/2-1/2	R1/2	G1/2	17,5	14	31,5	9,5	20	63
2020 3/4-3/4	R3/4	G3/4	19	16	36,5	16,5	25	126
2020 1-1	R1	G1	23	17	45	19	30	209

### Racores Mod. 2050

T.M.M.F.

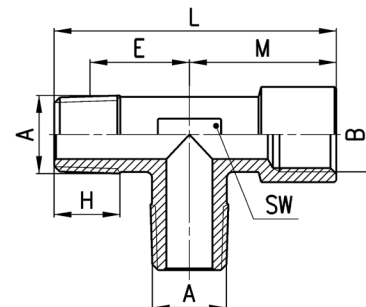

DIMENSIONES								
Mod.	A	B	E	H	L	M	SW	Peso (g)
2050 1/8-1/8	R1/8	G1/8	11,5	8,5	37	19	12	27
2050 1/4-1/4	R1/4	G1/4	15	11	46	23	13	35
2050 3/8-3/8	R3/8	G3/8	15	11,5	48,5	25	16	44
2050 1/2-1/2	R1/2	G1/2	17,5	14	60,5	31,5	20	83



### Racores Mod. 2060

T.F.M.F.

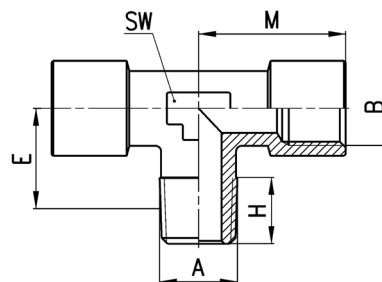

DIMENSIONES							
Mod.	A	B	E	H	M	SW	Peso (g)
2060 1/8-1/8	R1/8	G1/8	11,5	8,5	19	12	22
2060 1/4-1/4	R1/4	G1/4	15	11	23	13	38
2060 3/8-3/8	R3/8	G3/8	15	11,5	25	16	49
2060 1/2-1/2	R1/2	G1/2	17,5	14	31,5	20	89

### Racores Mod. 2080

Te Macho

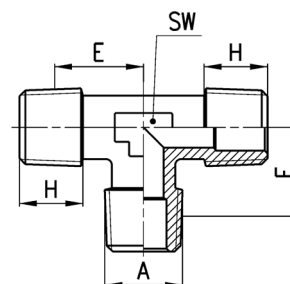

DIMENSIONES					
Mod.	A	E	H	SW	Peso (g)
2080 1/8	R1/8	11,5	7,5	9	14
2080 1/4	R1/4	13,5	11	12	25
2080 3/8	R3/8	15,5	11,5	14	39
2080 1/2	R1/2	16	14	16	82
2080 3/4	R3/4	19	16,2	25	135
2080 1	R1	23	17,5	30	239

### Racores Mod. 2070

T.M.F.F.

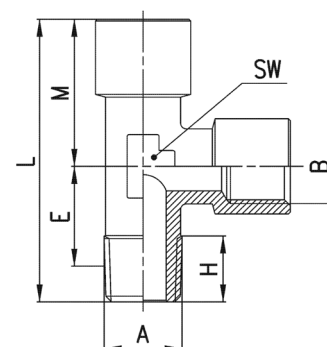

DIMENSIONES								
Mod.	A	B	E	H	L	M	SW	Peso (g)
2070 1/8-1/8	R1/8	G1/8	11,5	8,5	37	19	12	22
2070 1/4-1/4	R1/4	G1/4	15	11	46	23	13	37
2070 3/8-3/8	R3/8	G3/8	15	11,5	48,5	25	16	49
2070 1/2-1/2	R1/2	G1/2	17,5	14	60,5	31,5	20	89

### Racores Mod. 2090

T.M.F.M.

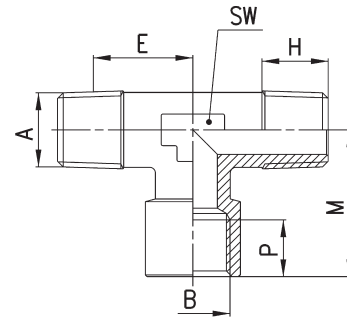

DIMENSIONES								
Mod.	A	B	E	H	M	P	SW	Peso (g)
2090 1/8-1/8	R1/8	G1/8	11,5	8,5	19	6	12	22
2090 1/4-1/4	R1/4	G1/4	15	11	23	7	13	37
2090 3/8-3/8	R3/8	G3/8	15	11,5	25	8	16	44
2090 1/2-1/2	R1/2	G1/2	17,5	14	31,5	9,5	20	83
2090 3/4-3/4	R3/4	G3/4	19	16	36,5	16,5	25	156
2090 1-1	R1	G1	23	17,5	45	19	30	262

### Racores Mod. 2003

Te Hembra

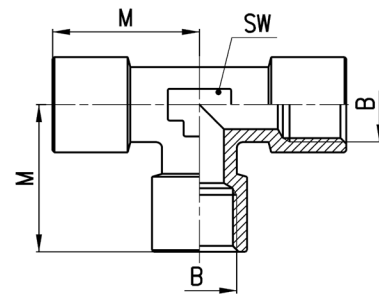

DIMENSIONES				
Mod.	B	M	SW	Peso (g)
2003 1/8	G1/8	19	12	23
2003 1/4	G1/4	23	13	39
2003 3/8	G3/8	25	16	54
2003 1/2	G1/2	31,5	20	97

### Racores Mod. 2040

Y.F.M.F.

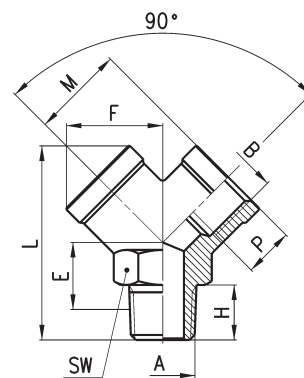

DIMENSIONES										
Mod.	A	B	E	F	H	L	M	P	SW	Peso (g)
2040 1/8-1/8	R1/8	G1/8	9,5	14,5	8	32	14	8	13	22
2040 1/4-1/4	R1/4	G1/4	12	18	11	38	17,5	11	17	38
2040 3/8-3/8	R3/8	G3/8	13,5	20,5	11,5	42,5	19	11,5	20	52
2040 1/2-1/2	R1/2	G1/2	15,5	26,5	14	53	24,5	14	25	110

### Racores Mod. 2043

Y Hembra

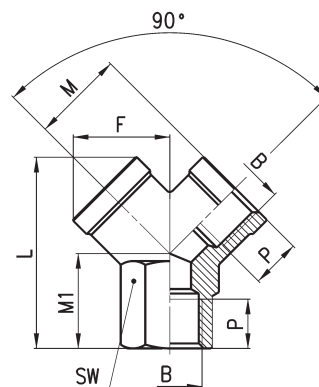

DIMENSIONES									
Mod.	B	F	L	M	M1	P	SW	Peso (g)	
2043 1/8	G1/8	14,5	26,5	14	12	8	13	18	
2043 1/4	G1/4	18	32	17,5	14	11	17	32	
2043 3/8	G3/8	20,5	37	19	16	11,5	20	44	
2043 1/2	G1/2	26,5	45	24,5	19	14	25	84	

### Racores Mod. 2033

Cruz Hembra

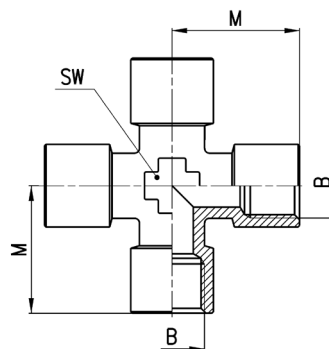

DIMENSIONES				
Mod.	B	M	SW	Peso (g)
2033 1/8	G1/8	19	12	27
2033 1/4	G1/4	23	14	51
2033 3/8	G3/8	25	16	70

### Racores Mod. 2023

Anillo Individual Roscado

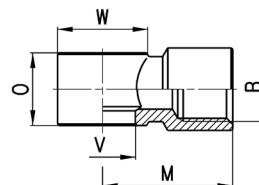

DIMENSIONES							
Mod.	B	M	O	V	W	Peso (g)	ensamblables con Mod.
2023 M5-M5	M5	10.5	9	5.1	9	6	1631
2023 M5-M6	M5	10.5	9	5.1	9	6	SCU, SVU, SCO...
2023 1/8-1/8	G1/8	20	14.5	9.8	∅ 14	14	1631, 1635, SCU, SVU, SCO...
2023 1/4-1/4	G1/4	23.5	14.5	13.2	∅ 18	21	1635, SCU, SVU, SCO...
2023 3/8-3/8	G3/8	26.5	14.5	16.7	∅ 21	27	1635, SCU, SVU, SCO...

### Accesorio Mod.3033

Colector 4 Vías con orificios de fijación  
Material: AL anodizado

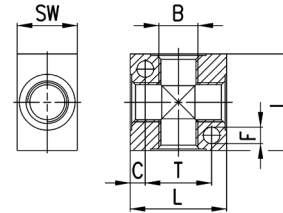

DIMENSIONES							
Mod.	B	C	F	L	T	SW	Peso (g)
3033 1/8	G1/8	4	4,5	25	17	16	18
3033 1/4	G1/4	5	5,5	32	22	20	35
3033 3/8	G3/8	7	5,5	40	26	25	73
3033 1/2	G1/2	8	5,5	50	34	30	137

### Accesorio Mod. 3043

Colector con Salidas contrapuestas  
Material: AL anodizado

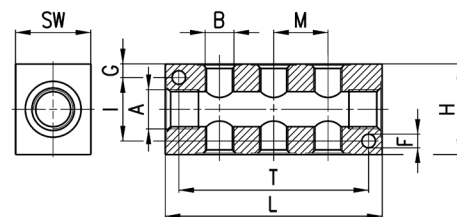

DIMENSIONES												
Mod.	A	SALIDAS LATERALES DOBLES	B	F	G	H	I	L	M	T	SW	Peso (g)
3043 1/4-3D-1/8	G1/4	3	G1/8	4.5	4.5	30	21	72	18	63	20	85
3043 1/4-4D-1/8	G1/4	4	G1/8	4.5	4.5	30	21	90	18	81	20	107
3043 1/4-5D-1/8	G1/4	5	G1/8	4.5	4.5	30	21	108	18	99	20	128
3043 1/4-6D-1/8	G1/4	6	G1/8	4.5	4.5	30	21	126	18	117	20	151
3043 3/8-3D-1/4	G3/8	3	G1/4	5.5	6	40	28	92	24	75	25	177
3043 3/8-4D-1/4	G3/8	4	G1/4	5.5	6	40	28	116	24	99	25	224
3043 3/8-5D-1/4	G3/8	5	G1/4	5.5	6	40	28	140	24	123	25	270
3043 3/8-6D-1/4	G3/8	6	G1/4	5.5	6	40	28	164	24	147	25	315
3043 1/2-3D-3/8	G1/2	3	G3/8	5.5	6.5	50	37	104	26	85	30	287
3043 1/2-4D-3/8	G1/2	4	G3/8	5.5	6.5	50	37	130	26	111	30	356
3043 1/2-5D-3/8	G1/2	5	G3/8	5.5	6.5	50	37	156	26	137	30	427
3043 1/2-6D-3/8	G1/2	6	G3/8	5.5	6.5	50	37	182	26	163	30	495

**Accesorio Mod. 3053**

Colector con Salidas laterales

Material: AL anodizado

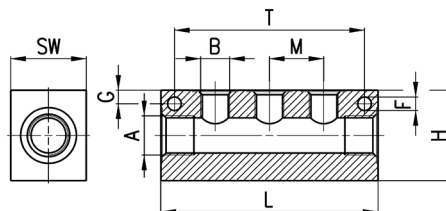

DIMENSIONES											
Mod.	A	SALIDAS LATERALES SINGULARES	B	F	G	H	L	M	T	SW	Peso (g)
3053 1/4-3L-1/8	G1/4	3	G1/8	4,5	4,5	30	72	18	63	20	92
3053 1/4-4L-1/8	G1/4	4	G1/8	4,5	4,5	30	90	18	81	20	116
3053 1/4-5L-1/8	G1/4	5	G1/8	4,5	4,5	30	108	18	99	20	140
3053 1/4-6L-1/8	G1/4	6	G1/8	4,5	4,5	30	126	18	117	20	164
3053 3/8-3L-1/4	G3/8	3	G1/4	5,5	6	40	92	24	75	25	191
3053 3/8-4L-1/4	G3/8	4	G1/4	5,5	6	40	116	24	99	25	243
3053 3/8-5L-1/4	G3/8	5	G1/4	5,5	6	40	140	24	123	25	294
3053 3/8-6L-1/4	G3/8	6	G1/4	5,5	6	40	164	24	147	25	345
3053 1/2-3L-3/8	G1/2	3	G3/8	5,5	6,5	50	104	26	85	30	313
3053 1/2-4L-3/8	G1/2	4	G3/8	5,5	6,5	50	130	26	111	30	395
3053 1/2-5L-3/8	G1/2	5	G3/8	5,5	6,5	50	156	26	137	30	474
3053 1/2-6L-3/8	G1/2	6	G3/8	5,5	6,5	50	182	26	163	30	551

RACORES ACCESORIOS SERIE 2000

# Enchufes rápidos Serie 5000

Diámetros nominales: 5, 7 mm - Conexiones: G1/8, G1/4, G3/8, G1/2  
 Tubos de plástico: 6/4 - 8/6 - 10/8  
 Tubos de goma: 6x14 - 8x17 - 10x19 - 13x23



Los enchufes rápidos Serie 5000 son ideales en todas aquellas situaciones donde por motivos de instalación o de seguridad se tienen que conectar o desconectar con frecuencia las conexiones de una instalación. Esta operación es efectuada sin tener que quitar la presión, por lo tanto con notable ahorro de tiempo.

Los enchufes rápidos Serie 5000 con perfil Mini DN 5 son compatibles con los enchufes del tipo Rectus Serie 21 - 90, Legris 21.  
 Los enchufes rápidos Serie 5000 con perfil Europeo DN 7 son compatibles con los enchufes del tipo Cejn Serie 320.

## CARACTERÍSTICAS GENERALES

Grupo válvula	grifo rápido automático
Construcción	con obturador
Sujeción	roscada
Roscas	GAS cilíndrico ISO 228 (BSP)
Materiales	latón niquelado (acero cementado y cincado solo cincado solo para aquellos con tercera cifra 8 en el código) juntas NBR
Conexiones	G1/8 - G1/4 - G3/8 - G1/2 - tubo plástico e tubo goma
Temperatura de trabajo	0°C ÷ 80°C (con aire seco - 20°C)
Presión de trabajo	- 0,99 ÷ 12 bar
Presión nominal	6 bar
Caudal nominal	ver tabla
Diámetro nominal	ø5 - ø7
Fluido	aire comprimido y otros fluidos a baja presión

## Enchufes rápidos

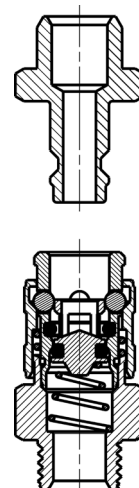

### Diagrama de caudal

El diagrama que aparece, sirve para dar una orientación al usuario acerca del modelo a utilizar en relación a la presión de trabajo y al caudal necesario. Las mediciones han sido efectuadas con los modelos abajo indicados y representan la condición ideal del máximo caudal. En el caso de que se utilicen tubos inferiores, se tendrá que considerar un menor rendimiento.

$Q$  (NI / min) = caudal  
 $\Delta p$  (bar) = variación de presión

$P_a$  (bar) = presión de entrada

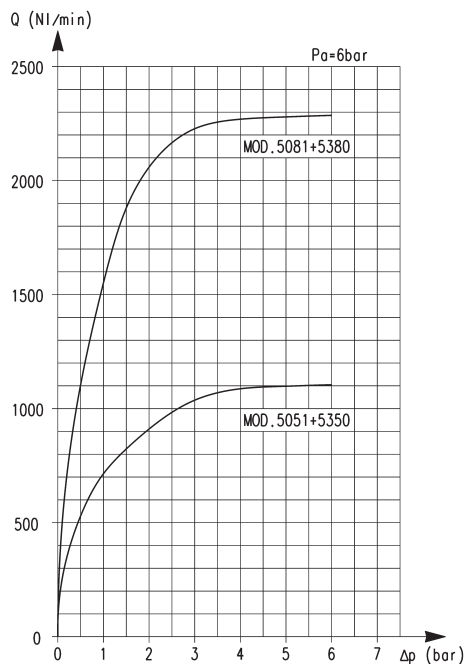

**Racores Mod. 5051 Serie mini y Mod. 5081 Estandár Europeo**



Enchufe Macho Cilíndrico

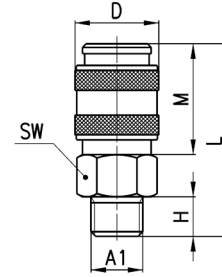

DIMENSIONES								
Mod.	A1	∅	D	H	L	M	SW	Peso (g)
5051 1/8	G1/8	5	17	6	35	20,5	14	28
5051 1/4	G1/4	5	17	8	37	20,5	17	37
5081 1/4	G1/4	7	25	8	47,5	34,5	22	93
5081 3/8	G3/8	7	25	9	48,5	34,5	22	92
5081 1/2	G1/2	7	25	10	49,5	34,5	24	107



**Racores Mod. 5052 serie mini y Mod. 5082 Estandár de Europa**



Enchufe macho pasamuros cilíndricos

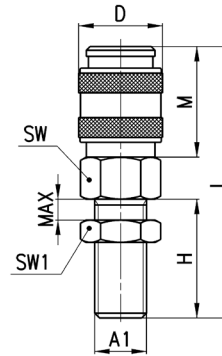

DIMENSIONES										
Mod.	A1	∅	D	H	L	M	max	SW	SW1	Peso (g)
5052 1/8	G1/8	5	17	23	52	20,5	12	14	14	38
5052 1/4	G1/4	5	17	24	53	20,5	12	17	17	52
5082 1/4	G1/4	7	25	24	63,5	34,5	12	22	17	103



**Racores Mod. 5053 serie mini y Mod. 5083 - Estandár de Europa**



Enchufe hembra cilíndrico

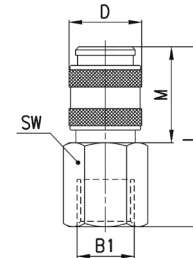

DIMENSIONES								
Mod.	B1	∅	D	L	M	SW	Peso (g)	
5053 1/8	G1/8	5	17	37,5	20,5	14	33	
5053 1/4	G1/4	5	17	39,5	20,5	17	44	
5083 1/4	G1/4	7	25	47,5	34,5	17	88	
5083 3/8	G3/8	7	25	49	34,5	20	93	
5083 1/2	G1/2	7	25	53	34,5	24	103	



**Racores Mod. 5054 y Serie Mini Mod. 5084 - Estandár de Europa**



Enchufe de cánula

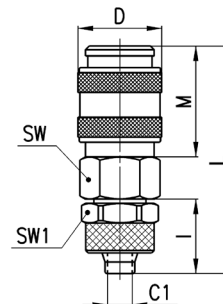

DIMENSIONES										
Mod.	Tubo	∅	C1	D	I	L	M	SW	SW1	Peso (g)
5054 6/4	6/4	5	3	17	15	44	20,5	14	12	36
5054 8/6	8/6	5	5	17	15	44	20,5	14	14	38
5084 8/6	8/6	7	5	25	15	54,5	34,5	22	14	99
5084 10/8	10/8	7	6,5	25	16,5	56	34,5	22	16	103

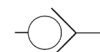



**Racores Mod. 5055 Serie Mini**



Enchufe Pasamuros y de cánula

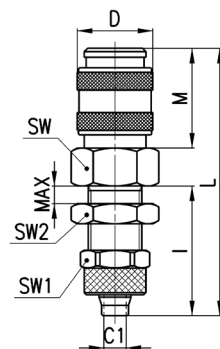

DIMENSIONES												
Mod.	Tubo	∅	C1	D	I	L	M	Max	SW	SW1	SW2	Peso (g)
5055 6/4	6/4	5	3	17	29	58	20.5	10	14	12	14	44
5055 8/6	8/6	5	5	17	29	58	20.5	11	17	14	17	52

**Racores Mod. 5056 Serie Mini y Mod. 5086 Estandár Europeo**



Enchufe Dentado

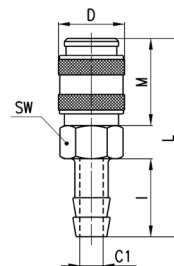

DIMENSIONES									
Mod.	N	∅	C1	D	I	L	M	SW	Peso (g)
5056 06	6	5	3	17	20	49	20.5	14	30
5056 09	9	5	5	17	20	49	20.5	14	32
5086 09	9	7	5	25	20	59,5	34,5	22	95
5086 12	12	7	8	25	20	59,5	34,5	22	96

**Racores Mod. 5057 Serie Mini y Mod. 5087 Estandár Europeo**



Enchufe manguera

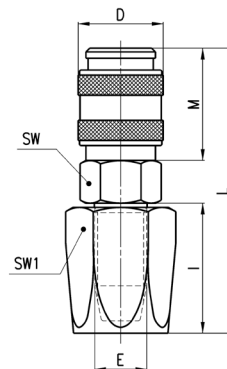

DIMENSIONES										
Mod.	Tubo	∅	E	D	I	L	M	SW	SW1	Peso (g)
5057 6x14	6 x 14	5	9	17	25	54,5	20,5	17	17	62
5087 6x14	6 x 14	7	9	25	25	64,5	34,5	22	17	117
5087 8x17	8 x 17	7	10	25	25	64,5	34,5	22	19	123
5087 10x19	10 x 19	7	12	25	27	66,5	34,5	22	22	141
5087 13x23	13 x 23	7	15	25	37	76,5	34,5	22	27	195

**Racores Mod. 5058 Serie Mini y Mod. 5088 Estandár de Europa**



Enchufe con muelle

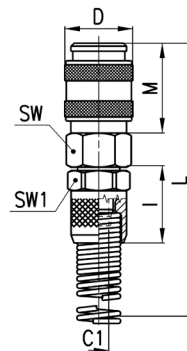

DIMENSIONES										
Mod.	Tubo	∅	C1	D	I	M	L	SW	SW1	Peso (g)
5058 6/4	6/4	5	3	17	19	20.5	120.5	14	14	48
5058 8/6	8/6	5	5	17	19	20.5	124.5	14	14	54
5088 8/6	8/6	7	5	25	19	34,5	135	22	14	118
5088 10/8	10/8	7	6,5	25	21,5	34,5	139,5	22	16	125

**Racores Mod. 5150 perfil mini y Mod. 5180 perfil Europeo**



Enchufe macho

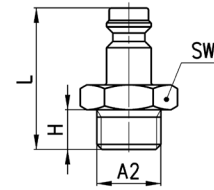

DIMENSIONES						
Mod.	A2	∅	H	L	SW	Peso (g)
5150 1/8	G1/8	5	6	26	13	12
5150 1/4	G1/4	5	8	28,5	17	19
5180 1/4	G1/4	7	8	33	17	21
5180 3/8	G3/8	7	9	34	19	26
5180 1/2	G1/2	7	10	35,5	24	34

**Racores Mod. 5350 Perfil Mini y Mod. 5380 Perfil Europeo**



Enchufe hembra

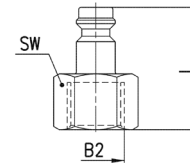

DIMENSIONES					
Mod.	B2	∅	L	SW	Peso (g)
5350 1/8	G1/8	5	25,5	13	14
5350 1/4	G1/4	5	27,5	17	18
5380 1/4	G1/4	7	31,5	17	21
5380 3/8	G3/8	7	32,5	19	23
5380 1/2	G1/2	7	36,5	24	37

**Racores Mod. 5450 Perfil Mini y Mod. 5480 Perfil Europeo**



Enchufe de Cánula

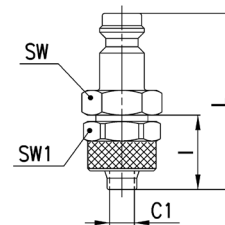

DIMENSIONES								
Mod.	Tubo	∅	C1	I	L	SW	SW1	Peso (g)
5450 6/4	6/4	5	3	15	35	12	12	17
5450 8/6	8/6	5	5	15	35	13	14	22
5480 8/6	8/6	7	5	15	39,5	14	14	25
5480 10/8	10/8	7	6,5	16,5	41,5	17	16	33

**Racores Mod. 5650 Perfil mini y Mod. 5680 Perfil Europeo**



Enchufe de Cánula

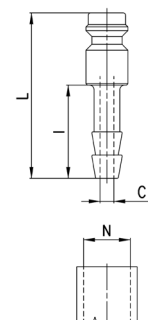

DIMENSIONES						
Mod.	N	∅	C1	I	L	Peso (g)
5650 06	6	5	3	20	35,5	8
5650 09	9	5	5	20	35,5	11
5680 06	6	7	3	20	40	14
5680 09	9	7	5	20	40	15
5680 12	12	7	7	20	40	19

**Racores Mod. 5750 Serie mini y Mod. 5780 estándar Europeo**



Enchufe manguera

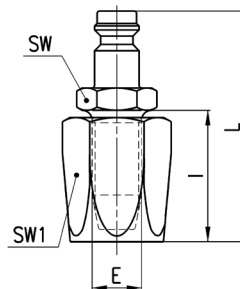

DIMENSIONES								
Mod.	Tubo	Ø	E	I	L	SW	SW1	Peso (g)
5750 6x14	6 X 14	5	9	25	45	14	17	40
5780 6x14	6 X 14	7	9	25	50	14	17	44
5780 8x17	8 X 17	7	10	25	50	14	19	50
5780 13x23	13 X 23	7	15	37	62	19	27	123

**Racores Mod. 5850 Perfil Mini y Mod. 5880 Perfil Europeo**



Enchufe con muelle

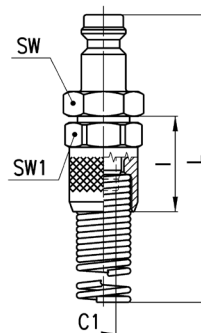

DIMENSIONES								
Mod.	Tubo	Ø	C1	I	L	SW	SW1	Peso (g)
5850 6/4	6/4	5	3	19	111,5	12	12	27
5850 8/6	8/6	5	5	19	116	14	14	40
5880 8/6	8/6	7	5	19	120	14	14	44
5880 10/8	10/8	7	6,5	21,5	125	17	16	55

# Enchufes rápidos Series 5000L y 5000LT para la refrigeración de moldes de inyección de plástico

Diámetros nominales: 5, 7 mm  
Conexiones: G1/8, G1/4, G3/8



Los enchufes rápidos de las Series 5000L y 5000LT han sido diseñados para la conexión de los tubos de agua, aire y aceite en los moldes de inyección de plástico y fundición.

Los enchufes rápidos de las Series 5000L y 5000LT permiten un método rápido para la conexión y desconexión de los circuitos de refrigeración del molde, como colectores de agua u otras fuentes.

- » Enchufes Serie 5000L: sin agujero pasante
- » Enchufes Serie 5000LT: con agujero pasante

## DATO GENERALES

Grupo válvula	grifo rápido automático
Construcción	con obturador
Sujeción	roscada
Roscas	GAS cilíndrico ISO 228 (BSP)
Conexiones	G1/8 - G1/4 - G3/8
Materiales	Cuerpo de latón Bolas y muelles de acero inoxidable Juntas de FKM
Temperatura de trabajo	-15°C ÷ 140°C (200°C con aceite)
Presión de trabajo	-0.99 ÷ 12 bar
Presión nominal	6 bar
Caudal nominal	ver diagramas de caudal en la página siguiente
Diámetro nominal	ø5 - ø7
Fluidos	agua, aire y aceite

**Principio de funcionamiento y diagrama de caudal en AGUA para enchufes tipo "L"**

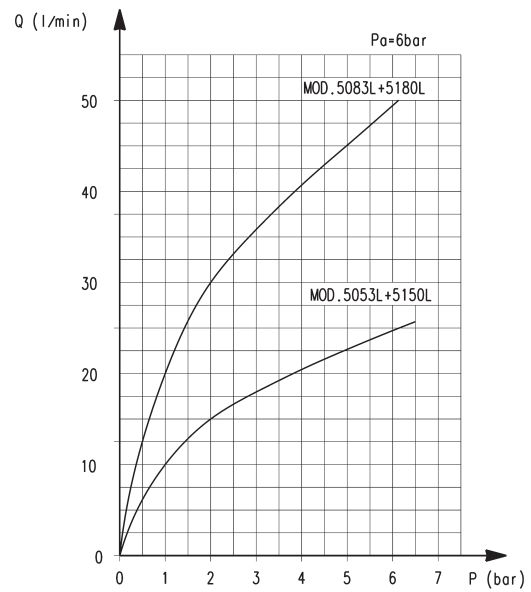
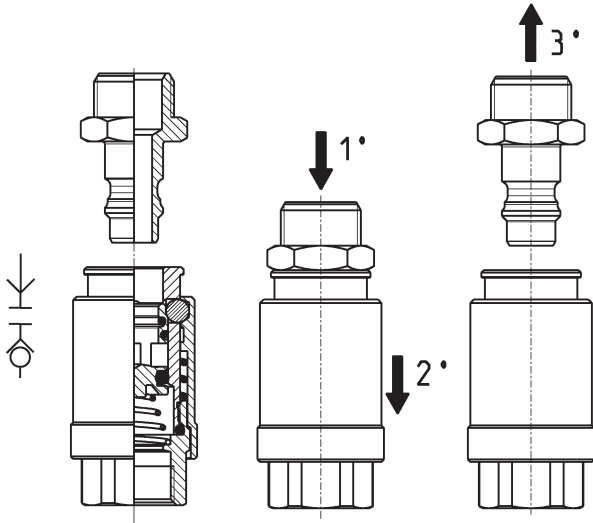

Los enchufes hembras están diseñados para evitar la liberación accidental. La liberación solo puede ocurrir presionando el enchufe macho hacia dentro (1 °) y luego la tuerca de acoplamiento hembra (2 °) y finalmente tire del acoplamiento macho hacia afuera (3 °).

Los enchufes rápidos hembra son realizados para evitar la pérdida de líquido durante las operaciones de acoplamiento y desacoplamiento.

Q (l/min) = Caudal - P = pérdida de carga  
Pa (bar) = presión de entrada

El diagrama da una indicación del modelo a utilizar en relación a la presión de trabajo y al caudal necesario. Las mediciones han sido efectuadas con los modelos indicados y representan la condición ideal del máximo caudal. En el caso de que se utilicen tubos inferiores, se tendrá que considerar un menor rendimiento.

**Principio de funcionamiento y diagrama de caudal en AGUA para enchufes tipo "LT"**

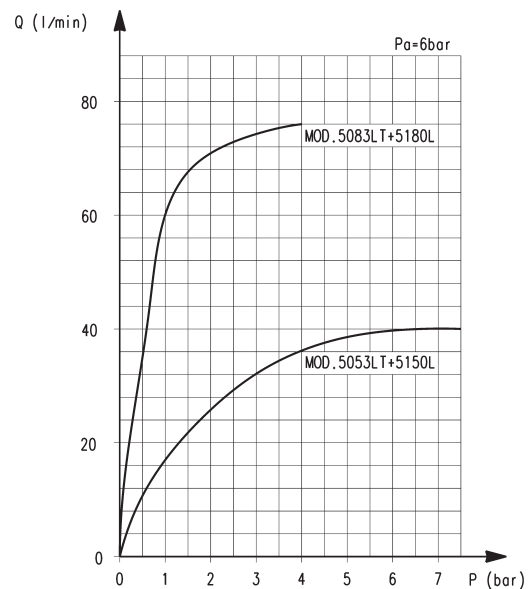
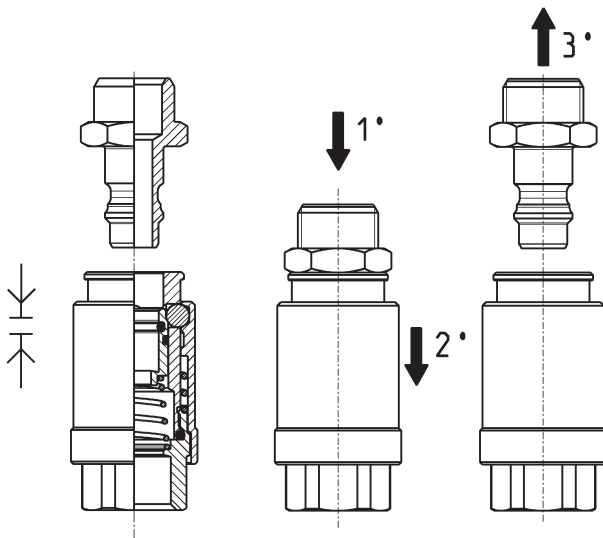

Los enchufes hembra están diseñados para evitar la liberación accidental. La liberación solo puede ocurrir presionando el enchufe macho hacia dentro (1 °) y luego la tuerca de acoplamiento hembra (2 °) y finalmente tire del acoplamiento macho hacia afuera (3 °). Para aplic. que requieren un caudal más alto, está disponible la versión del enchufe hembra con agujero pasante. Esta solución permite un mayor caudal del fluido, pero no evita la pérdida de líquido durante las op. de desacoplamiento.

Q (l/min) = Caudal - P = pérdida de carga  
Pa (bar) = presión de entrada

El diagrama da una indicación del modelo a utilizar en relación a la presión de trabajo y al caudal necesario. Las mediciones han sido efectuadas con los modelos indicados y representan la condición ideal del máximo caudal. En el caso de que se utilicen tubos inferiores, se tendrá que considerar un menor rendimiento.

### Racores Mod. 5053L y 5053LT



Enchufe rápido hembra BSP

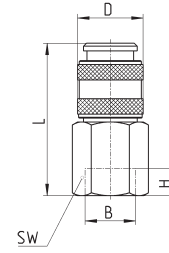

Mod.	B	D	H min	L	SW	peso (g)	Símbolo
5053L 1/8	G1/8	17	6	37	14	34	VNR3
5053L 1/4	G1/4	17	7	39	17	44	VNR3
5053LT 1/8	G1/8	17	6	37	14	34	VNR2
5053LT 1/4	G1/4	17	7	39	17	44	VNR2



### Racores Mod. 5083L y 5083LT



Enchufe rápido hembra BSP

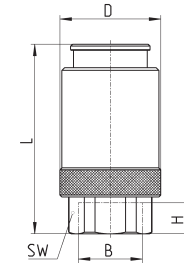

Mod.	B	D	H min	L	SW	peso (g)	Símbolo
5083L 1/4	G1/4	26	10	47.5	17	104	VNR3
5083L 3/8	G3/8	26	8	49	20	110	VNR3
5083LT 1/4	G1/4	26	10	47.5	17	104	VNR2
5083LT 3/8	G3/8	26	8	49	20	110	VNR2



### Racores Mod. 5150L y 5180L



Enchufe macho

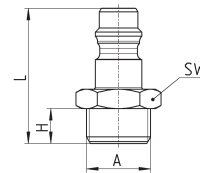

Mod.	A	H	L	SW	peso (g)
5150L 1/8	G1/8	6	26.5	13	11
5150L 1/4	G1/4	8	29	17	17
5180L 1/4	G1/4	8	34	17	21
5180L 3/8	G3/8	9	35	19	25



# Tubos, espirales y accesorios Serie T, MPL, PNZ

Tubos : PVC reforzado, Poliamida PA12, Poliéster Hytrel,  
Polietileno, PU  
Diámetros: 4/2, 5/3, 6/4, 8/6, 10/8, 12/10, 15/12,5 mm



Camozzi ofrece una gama de tubos y espirales con características específicas que los hacen adecuados para muchas de las necesidades técnicas de los usuarios finales. Gracias al empleo de materias primas de alta calidad y con un bajo peso específico, estos productos tienen dimensiones y pesos muy reducidos. Tienen una excelente resistencia a la tensión, flexión y a las vibraciones.

La alta specularidad de las superficies interiores de paso de fluidos (rugosidad de aproximadamente 0,6 micras) permite reducir al mínimo las pérdidas de carga obteniendo caudales significativamente más elevados a igualdad del diámetro. Los tecnopolímeros utilizados son particularmente resistentes al envejecimiento, garantizando una larga duración.

### Tubos Mod. PV



Tubos en PVC reforzado

Color estándar: Azul

Mod.	D/d	Presión max a 20°C (bar)	Peso (g/m)	Radio min. de la curva (mm)	Tamaño mt
PV 6/4	6/4	40	22	50	50
PV 8/6	8/6	38	30	60	50
PV 10/8	10/8	30	40	65	50
PV 12/10	12/10	24	56	80	50
PV 15/12,5	15/12.5	18	70	90	50

### Tubos Mod. TRN



Tubos en Poliamida PA12

Color estándar: neutro

Colores disponibles bajo pedido:

Azul - Rojo - Verde - Negro - Amarillo

Mod.	D/d	Presión max a 23°C (bar)	Peso g/mt	Radio min. de la curva (mm)	Tamaño mt
TRN 4/2	4/2	44	9.7	16	100
TRN 5/3	5/3	33	12.9	20	100
TRN 6/4	6/4	28	16.2	30	100
TRN 8/6	8/6	20	22.6	40	100
TRN 10/8	10/8	16	29.1	60	50
TRN 12/10	12/10	12	35.6	85	50

### Tubos Mod. TRH



Tubos en poliéster Hytrel

Color estándar: azul

Colores disponibles bajo pedido:

Rojo - Verde - Negro - Amarillo - Blanco

Mod.	D/d	Presión max a 23°C (bar)	Peso (g/m)	Radio min. de la curva (mm)	Tamaño mt
TRH 4/2-Z	4/2	32	11.5	16	100
TRH 5/3-Z	5/3	27	15.3	25	100
TRH 6/4-Z	6/4	21	19.2	35	100
TRH 8/6-Z	8/6	15	26.8	65	100
TRH 10/8-Z	10/8	12	34.5	100	50
TRH 12/10-Z	12/10	10	42.1	125	50



**Tubos Mod. TPE**



Tubo en Polietileno de baja densidad  
 Color estándar: neutro  
 Colores disponibles bajo pedido: Azul

Mod.	D/d	Presión max a 23°C (bar)	Peso (g/m)	Radio min. de la curva (mm)	Tamaño (m)
TPE 5/3	5/3	17	11.3	23	100
TPE 6/4	6/4	13	14.1	32	100
TPE 8/6	8/6	10	19.8	43	100
TPE 10/8	10/8	7	25.4	76	100

**Tubos Mod. TPC**



Tubos en Poliuretano 98 Shore  
 Color estándar: Gris RAL 7012

Mod.	D/d	Presión max a 23°C (bar)	Peso (g/m)	Radio min. de la curva (mm)	Tamaño mt
TPC 4/2	4/2	19	11.5	11	100
TPC 6/4	6/4	13	19.2	18	100
TPC 8/6	8/6	9	26.8	35	100
TPC 10/8	10/8	7	34.5	45	100
TPC 12/8	12/8	9	76.6	50	100

**Tubo Mod. TSP**



Espiral en Rilsan (PA 11)  
 Color estándar: Azul  
 Otros colores disponibles bajo pedido

Mod.	D/d	Presión max a 20°C (bar)	Ø externo	Longitud cerrada (mm)	Longitud abierta (mm)
TSP 6/4	6/4	20	64	1000	15000
TSP 8/6	8/6	14	86	1000	15000
TSP 10/8	10/8	11	102	1050	15000
TSP 12/10	12/10	9	126	1050	15000

## Regleta porta tubos de plástico Mod. MPL

Color: Azul

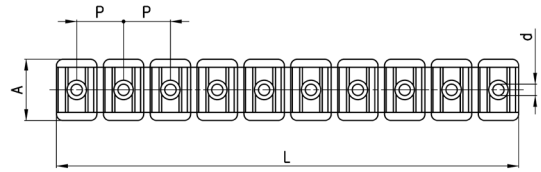

Mod.	Ø Tubo	L	A	d	P	Núm. posiciones
MPL-4	4	114	19	2.8	11.7	10
MPL-6	6	114	19	2.8	11.7	10
MPL-8	8	143	19	3.8	14.6	10
MPL-10	10	172	19	5.3	17.4	10
MPL-12	12	162	19	5.3	20.5	8
MPL-14	14	180	19	5.3	22.5	8

## Pinzas cortatubo Mod. PNZ... y PNZP-12

Pinzas cortatubo Mod. PNZ: las cuchillas de repuesto se pueden pedir por separado.

Pinza cortatubo Mod. PNZP-12: de plástico.



PNZ-...



PNZP-12

Mod.	
PNZ-12	para cortar tubos Ø hasta 12 mm
PNZ-25	para cortar tubos Ø hasta 25 mm
PNZP-12	para cortar tubos Ø hasta 12 mm

## Línea de tubería de corte

**Novedad**

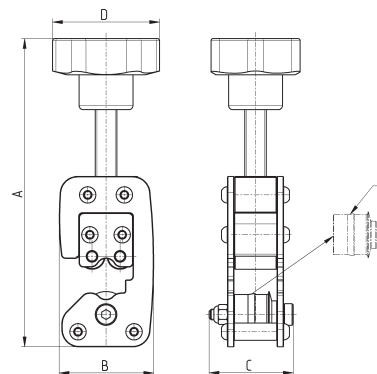

Mod.	Ø Tubo	A (max)	B	C	D	Peso (g)	E (rueda de repuesto)
8TRT 4	4	138	43.5	39	50	450	RTRT 4
8TRT 6	6	140	43.5	39	50	450	RTRT 6
8TRT 8	8	143	44	39	50	450	RTRT 8
8TRT 10	10	145	44	39	50	450	RTRT 10
8TRT 12	12	147	44.5	39	50	450	RTRT 12
8TRT 14	14	149	45	39	50	450	RTRT 14
8TRT 16	16	151	45	39	50	450	RTRT 16





# Calidad: nuestro compromiso prioritario

Investigación, innovación tecnológica, entrenamiento, respeto por el personal, seguridad ambiental, y cuidado total a los clientes, son todos factores que Camozzi considera estratégicos en el logro de la calidad, reflejando un compromiso total en la búsqueda de la excelencia.

Para Camozzi la calidad es un sistema de calidad que asegure la excelencia, no solamente en el producto final sino en todos los procesos del negocio.



CALIDAD: NUESTRO COMPROMISO PRIORITARIO

## Nuestras certificaciones

Una de las principales metas de Camozzi, además de la calidad y la seguridad es la protección del medio ambiente y compatibilidad de nuestras actividades con el contexto territorial en cuál ellas son llevadas a cabo.

Desde 1993 Camozzi ha estado certificado de acuerdo a la norma ISO 9001 y en el 2003 la compañía obtuvo la certificación ISO 14001.

Nello stesso anno il DNV ha certificato il Sistema di gestione Integrato comprendente entrambe le norme. En el mismo año, DNV certificó el Sistema de Administración Integrado que incluye ambas normas. Además, en 2013 Camozzi obtuvo la certificación ISO/TS 16949 para los racores C-Truck en 2013 Camozzi obtuvo la certificación ISO/TS 16949 para la Serie C-Truck y para la Serie 9000 de racores para fuel, que luego pasaron a la nueva edición del IATF Estándar 16949 en 2018.

Desde el 1° Julio 2003, todos los productos comercializados en la Unión Europea y destinados a ser utilizados en áreas potencialmente explosivas, deben ser aprobados de acuerdo a la directiva 94/9/CE mejor conocida como ATEX.

Esta nueva directiva cubre también las partes no eléctricas, por ejemplo válvulas de mando neumáticas deberían ser aprobadas. Desde el 19 Abril 2016 la Directiva ATEX es reemplazada por la nueva directiva 2014/34/EU.

### Directivas a cumplir

- Directiva 99/34/EC relacionado con la "Responsabilidad por productos defectuosos" modificada por el Decreto Legislativo 02/02/01 n° 25.
- Directiva 2014/35/UE "Equipos diseñados para uso dentro de ciertos voltajes eléctricos".
- Directiva 2014/30/UE "Compatibilidad Electromagnética EMC" e integraciones relacionadas
- Directiva 2014/34/UE "Atex".
- Directiva 2006/42/CE "Maquinaria".
- Directiva 2014/68/UE "Equipo a presión - PED".
- Directiva 2001/95/CE "Seguridad general de los productos".
- Regulación 1907/2006 relacionada con el Registro, Evaluación, Autorización y Restricción de Químicos (REACH).

### Normas técnicas

- ISO 4414 - Potencia de fluidos neumáticos - Reglas generales relacionados con los sistemas.

### Notas ambientales

- Empaque: nosotros respetamos el ambiente, usando materiales que pueden ser reciclados. El empaque consiste de bolsas plásticas de material PE reciclable y papel.
- Proyectos de Diseño Verde: en el estudio de nuevos productos, siempre es tomado en consideración el impacto ambiental. (Proyecto real, elaboración, etc.).

# Información para el uso de los productos Camozzi

Para garantizar el funcionamiento correcto de sus productos, Camozzi proporciona la siguiente información general.

## Calidad del aire

Además de respetar los valores límite de presión, fuerza, velocidad, voltaje, temperatura y otros valores que son indicados en las tablas generales de cada producto, otro aspecto a considerar es la calidad del aire comprimido. Mientras que los recursos como electricidad, agua y gas son normalmente suministrados por compañías externas que garantizan su calidad, el aire es producido dentro de la compañía y por lo tanto es el usuario quien tiene que garantizar su calidad.

Esta característica es esencial para un adecuado funcionamiento de los sistemas neumáticos. Un m<sup>3</sup> de aire a la presión atmosférica contiene varias substancias:

- más de 150 millones de partículas sólidas con tamaños desde 0,01 µm a 100 µm,
- humos debido a la combustión,
- vapor de agua, del cual la calidad depende de la temperatura, a 30° hay cerca de 30 g/m<sup>3</sup> de agua

- aceite, hasta cerca de 0,03 mg
- micro organismos
- así como diferentes contaminantes químicos, olores, etc ...

Al comprimir el aire, en el mismo volumen de 1 m<sup>3</sup>, encontramos "n" m<sup>3</sup> de aire, por lo tanto, las substancias indicadas arriba se incrementan.

Para limitar esto, se instalan filtros, secadores y separadores de aceite a la entrada y salida de los compresores.

A pesar de estas precauciones, el aire, durante su transporte dentro de las mangueras o almacenamiento en tanques, puede recibir partículas de óxido, además una parte del vapor de agua contenido en el aire, al enfriarse, puede pasar del estado gaseoso al estado líquido, pero también puede transformar el humo del aceite que no fue retenido por los filtros previos.

Por esta razón es aconsejable equipar los sistemas o maquinaria con grupos de tratamiento de aire llamadas unidades de mantenimiento FRL.

## Tratamiento del aire: clasificación de acuerdo a la norma ISO 8573-1-2010

ISO 8573-1-2010 Clase	Partículas sólidas			Máx. Concentración mg/m <sup>3</sup>	Agua		Aceite Contenido total (líquido, aerosol y vapor) mg/m <sup>3</sup>
	Máx. Número de Partículas por m <sup>3</sup> 0,1 - 0,5 µm	0,5 - 1 µm	1 - 5 µm		Agua a presión punto de rocío °C	Líquido g/m <sup>3</sup>	
0	Más estricto que la clase 1, definido por el usuario del dispositivo						
1	≤ 20,000	≤ 400	≤ 10	-	≤ - 70°	-	≤ 0,01
2	≤ 400,000	≤ 6,000	≤ 100	-	≤ - 40°	-	≤ 0,1
3	-	≤ 90,000	≤ 1,000	-	≤ - 20°	-	≤ 1
4	-	-	≤ 10,000	-	≤ + 3°	-	≤ 5
5	-	-	≤ 100,000	-	≤ + 7°	-	-
6	-	-	-	≤ 5	≤ + 10°	-	-
7	-	-	-	5 - 10	-	≤ 0,5	-
8	-	-	-	-	-	0,5 - 5	-
9	-	-	-	-	-	5 - 10	-
X	-	-	-	> 10	-	> 10	-

Estos grupos tienen diferentes funciones: válvulas de aislamiento, reguladores de presión, válvulas de apertura progresiva, y por supuesto filtros. Solamente en algunas aplicaciones, los lubricadores aún se utilizan. En relación al filtrado, hay normas de referencia como la ISO 8573-1-2010 que clasifica al aire de acuerdo a su calidad.

Esta norma define la clase del aire comprimido de acuerdo a la presencia de tres categorías de contaminantes: partes sólidas, agua o vapor de agua, concentración de micro neblina o vapor de aceite.

En general, si no se especifica otra cosa en las características de los componentes, los productos Camozzi requieren una calidad de aire **ISO 8573-1-2010 clase 7-4-4**, lo que significa lo siguiente:

### - clase 7

Una concentración máxima de partículas sólidas de 5 mg/m<sup>3</sup> es permitida y el tamaño no es declarado.

Los filtros Camozzi están declarados como clase 7, aún cuando los elementos de filtrado tienen una tecnología que permite separar partículas sólidas de tamaño mayor a 25 µm.

El aire que sale de nuestros filtros y es el que está a la entrada de todos los otros componentes, puede contener partículas sólidas con una máx. concentración de 5 mg/m<sup>3</sup> pero un tamaño máx. de 25 µm.

### - clase 4

La temperatura tiene que llegar a ≤ 3° para que el vapor de agua se condense y se haga líquido. Los filtros clásicos tienen características que separan la humedad del aire solamente si está en estado líquido o casi líquido. Es el enfriamiento del aire lo que permite la condensación y entonces la eliminación del agua presente en la forma de vapor de agua.

El flujo de aire que entra en el vaso del filtro experimenta una fase de expansión mínima, (de acuerdo a la ley de los gases, cuando un gas experimenta una súbita expansión, su temperatura baja) seguido por un vortice, que permite que las partículas más pesadas y el vapor de agua, que es condensado debido a la expansión, se adhiere a los lados del vaso y se desliza hacia el sistema de drenado. Excepto por versiones específicas, los filtros Camozzi son declarados ser clase 8. Esto significa que el usuario tiene que instalar secadores en su sistema de producción de aire comprimido que al enfriar el aire, lo dehumedifique.

### - clase 4

La concentración de partes de aceite debe ser máximo de 5 mg/m<sup>3</sup>. Los compresores usan aceite que durante el proceso puede ser introducido dentro del sistema en la forma de aerosol, vapor o líquido.

Este aceite, como todos los otros contaminantes, es transportado por el aire dentro del circuito neumático, y entra en contacto con los sellos de los componentes y posteriormente en el ambiente a través de los escapes de las electroválvulas. En este caso, los filtros coalescentes son usados y estos tienen principios de operación y elementos filtrantes que son diferentes comparados a otros y esto permite agregar esas micro-moléculas de aceite suspendidas en el aire y removerlas.

Los filtros coalescentes Camozzi permiten alcanzar clases 2 y 1. Es importante tener presente que el mejor desempeño es logrado solo por medio de un proceso de filtrado con fases subsecuentes.

Como se ilustra, hay filtros con diferentes características, un filtro muy eficiente para un cierto contaminante, no podría funcionar bien para otros contaminantes. Los elementos filtrantes determinan la clase de los filtros.

Estos elementos deberían ser reemplazados después de un cierto periodo de tiempo o de un cierto número de horas de trabajo.

Estos parámetros varían de acuerdo a las características del aire entrante.

### Los filtros Camozzi están subdivididos en diferentes grupos:

- Elemento filtrante 25 µm, clase 7-8-4
- Elemento filtrante de 5 µm, clase 6-8-4
- Elemento filtrante de 1 µm, clase 2-8-2 con pre-filtro clase 6-8-4
- Elemento filtrante de 0,01 µm, clase 1-8-1 con pre-filtro clase 6-8-4 contenido aceite content residual de 0,01 mg/m<sup>3</sup>
- Carbón activado, clase 1-7-1 con pre-filtro clase 1-8-1 contenido aceite residual de 0,003 mg/m<sup>3</sup>

Los componentes son engrasados previamente con productos especiales y no necesitan lubricación adicional. En caso que sea necesario lubricar, use aceite ISO VG 32. La cantidad de aceite introducido en el circuito depende de las diferentes aplicaciones. Se sugiere una dosis máxima de 3 gotas por minuto.

## Cilindros neumáticos

La elección correcta de la forma de montaje del cilindro en la estructura y la selección del accesorio del vástago para instalarse a cualquier parte móvil, es tan importante como el control de los parámetros como la velocidad, masa y cargas radiales. El control de dichos parámetros debe ser realizado por el usuario. La colocación de los detectores de posición (sensores reed) y sus tiempos de respuesta con los campos magnéticos dependen del tipo y diámetro del cilindro y se deben tomar precauciones para colocarlos apropiadamente. (ver notas en las páginas relativas a los sensores).

No se aconseja el uso de los cilindros como una aplicación de amortiguador o amortiguación neumática. Si se usa para una velocidad muy elevada, se recomienda una deceleración gradual para evitar un violento impacto entre el pistón y la culata del cilindro.

Como valor general, se calcula una velocidad máxima promedio de 1 m/seg. En este caso no se requiere lubricación ya que la lubricación realizada en su montaje es suficiente para garantizar un buen funcionamiento.

Si se requieren velocidades más elevadas, se sugiere una lubricación en las cantidades descritas anteriormente.

# Directiva ATEX 2014/34/EU: productos clasificados para su utilización en ambientes potencialmente explosivos



A partir del 19 de Abril 2016 todos los productos que sean comercializados en la Unión Europea y destinados a ser usados en **atmósferas potencialmente explosivas** tienen que ser aprobados de acuerdo a la directiva 2014/34/EU, también conocida como ATEX. Esta nueva directiva también se refiere a productos no eléctricos, como accionadores neumáticos, los cuales necesitan ser aprobados.

## Estos son los principales cambios de la nueva directiva 2014/34/EU:

- También aparatos y dispositivos no eléctricos, como cilindros neumáticos, son parte de la directiva
- Los aparatos son asignados a diferentes categorías, las cuales son asignadas a ciertas zonas potencialmente explosivas.
- Los productos son identificados con la marca CE - Ex.
- Las instrucciones para el uso y las declaraciones de conformidad deben ser entregadas con cada producto vendido usado en zonas potencialmente explosivas.
- Productos destinados a ser usados en zonas potencialmente explosivas, debido a la presencia de polvo, son incluidas de la misma forma que los productos destinados a ser usados en zonas con la presencia de gases peligrosos.

Una atmósfera potencialmente explosiva pudiera ser compuesta de gas, niebla, vapor o polvo que pudiera ser creado en procesos de manufactura o en todas esas áreas donde hay una constante o esporádica presencia de sustancias inflamables.

Una explosión puede ocurrir cuando hay una presencia de sustancias inflamables y una fuente de ignición en una atmósfera potencialmente explosiva.

## Una fuente de ignición podría ser:

- Eléctrica (arcos eléctricos, corriente inducida, calor generado por el efecto Joule)
- Mecánica (calor entre superficies causada por fricción, chispas generadas por el choque de cuerpos metálicos, descargas electrostáticas, compresión adiabática)
- Química (reacciones exotérmicas entre materiales)
- Flamas. Los productos que están sujetos a esta aprobación son aquellos, los cuales debido a su uso normal o debido a mal funcionamiento tenga una o mas fuentes de ignición para actuar en las atmósferas potencialmente explosivas.

El fabricante debe garantizar que el producto sea conforme a lo declarado y especificado en el marcado del mismo. Además el producto debe estar siempre acompañado de su correspondiente Instrucción.

El constructor de la instalación y/o utilizador debe individualizar la zona de riesgo en la cual se utilicen los productos en referencia a la directiva 99/92/CE y adquirir el producto conforme a la utilización en dicha zona predestinada prestando atención a los escritos en la relativa Instrucción.

**Cualquier producto compuesto por dos componentes de diverso marcado; el componente cuya clasificación sea la de categoría más baja determinará la clase de protección de todo el conjunto.**

Ejemplo:

Solenoides adaptados para la categoría 3 marcado...

Ex - II 3 Ex...

Y válvula adaptada para la categoría 2...

Ex - II 2 Ex...

El ensamblaje de la válvula con solenoide podrá colocarse únicamente en Categoría 3 o zona 2/22.

## Zonas, grupos y categoriass

En los lugares y por la tipología de la instalación sujetos a la directiva 99/92/CE el organismo competente debe efectuar la clasificación de las zonas en cuanto al peligro de formación de atmósferas explosivas por la presencia de gas o polvo.

Los dispositivos para utilización en zonas potencialmente explosivas se dividen en diversos GRUPOS:

GRUPO I: dispositivos usados en minería

GRUPO II: dispositivos usados en instalaciones de superficie

### Grupo I: Dispositivos usados en minas

CATEGORIA M1  
Funcionando en atmósferas explosivas

CATEGORIA M2  
Aparatos no alimentados en atmósferas explosivas

### Grupo II: Dispositivos para instalaciones usados en superficies

Categoría del producto	GAS	POLVO
1	Zona 0	Zona 20
2	Zona 1	Zona 21
3	Zona 2	Zona 22

## Clasificación de las zonas según la Directiva 99/92/CE

- Categoría 1** Zona 0 - Área en la cual (permanentemente, por períodos largos o a menudo) una atmósfera explosiva está presente, consistiendo en una mezcla de aire y inflamables en forma de gas, vapor o niebla.  
Zona 20 - Área en la cual (permanentemente, por períodos largos o a menudo) una atmósfera explosiva está presente en forma de una nube de polvo que sea combustible en el aire.
- Categoría 2** Zona 1 - Área en la cual, durante actividades normales, la formación de una atmósfera explosiva es probable, consistiendo en una mezcla de aire y inflamables en forma de gas, vapor o de niebla.  
Zona 21 - Área en la cual, ocasionalmente durante actividades normales, la formación de una atmósfera explosiva es probable, en la forma de una nube de polvo que es combustible en el aire.
- Categoría 3** Zona 2 - Área en la cual, durante actividades normales, la formación de una atmósfera explosiva, consistiendo en una mezcla de aire y inflamables en forma de gas, vapor o niebla no es probable y, siempre que éste deba ocurrir, será solamente de una duración corta.  
Zona 22 - Área en la cual, durante actividades normales, la formación de una atmósfera explosiva en forma de una nube de combustible de polvo no es probable y, siempre que éste deba ocurrir, será solamente de una duración corta.

**Ejemplo de marcado:** II 2 GD c T100°C (T5) -20°C ≤ Ta ≤ 60°C

<b>II</b>	Dispositivos que deben ser utilizados en espacios expuestos a riesgos de una atmósfera explosiva, diferentes de los espacios subterráneos, minas, túneles, etc., indicados según los criterios del apartado I de la Directiva 94/9/CE (ATEX).
<b>2</b>	Dispositivos diseñados para funcionar en conformidad con los parámetros operacionales determinados por el fabricante y garantizar un alto nivel de protección.
<b>GD</b>	Protegido contra gas (G) y polvos explosivos (D).
<b>c</b>	Dispositivos no eléctricos para las atmósferas potencialmente explosivas - Protegidos por una construcción reforzada para seguridad adicional.
<b>T 100°C</b>	Temperatura superficial máxima de 100°C con respecto a los peligros potenciales que pueden resultar con la proximidad de polvos peligrosos.
<b>T5</b>	Temperatura superficial máxima de 100°C con respecto a los peligros potenciales que pueden resultar dentro de ambientes gaseosos
<b>Ta</b>	Temperatura ambiente: -20°C ≤ Ta ≤ 60°C. Gama de temperaturas ambientales (con aire seco).

**Grupo I: Clases de temperatura**

Temperatura = 150°C  
 ó también = 450 °C según la capa de polvo acumulado sobre el aparato.

**Grupo II: Clases de temperatura**

Clases de temp. para gas (G)	Temp. superficial admisible
T1	450°C
T2	300°C
T3	200°C
T4	135°C
T5	100°C
T6	85°C

**Productos Camozzi certificados ATEX**

**APARATOS** con directiva ATEX - Grupo II

**Cilindros**

Serie	Categoría	Zona	Gas/Polvo
16*	2 DE-3 SE	1/21 DE -2/22 SE	G/D
24*	2 DE-3 SE	1/21 DE-2/22SE	G/D
25*	2 DE-3 SE	1/21 DE-2/22SE	G/D
31-32	2 DE-3 SE	1/21DE-2/22SE	G/D
31-32 Tandem/multi-posición	2 DE	1/21 DE	G/D
40*	2 DE	1/21 DE	G/D
41*	2 DE	1/21 DE	G/D
61*	2 DE-3 SE	1/21 DE-2/22 SE	G/D
63*	2 DE-3 SE	1/21 DE-2/22 SE	G/D
6PF*	2 DE	1/21 DE	G/D
27	2 DE	1/21 DE	G/D
QP-QPR	2 DE-3 SE	1/21 DE-2/22 SE	G/D
QN	3 SE	2/22 SE	G/D
42	2 DE-3 SE	1/21 DE-2/22 SE	G/D
ARP	2	1/21	G/D
QCT-QCB-QXT-QXB	2	1/21	G/D

**Sensores**

Serie	Categoría	Zona	Gas/Polvo
CSH/CST/CSV	3	2/22	G/D
CSG	3	2/22	G/D

**Válvulas**

Serie	Categoría	Zona	Gas/Polvo
P	3	2/22	G/D
W	3	2/22	G/D
Y	3	2/22	G/D

**Solenoides**

Serie	Categoría	Zona	Gas/Polvo
U70	3	2/22	G/D
H801**	2	1/21	G/D

**Presostatos**

Serie	Categoría	Zona	Gas/Polvo
PM 11**	1	0/20	G/D

**COMPONENTES** con directiva ATEX - Grupo II

**Productos**

Productos	Categoría	Zona	Gas/Polvo
Silenciadores	2	1/21	G/D
Enchufes rápidos	2	1/21	G/D
Manifolds	2	1/21	G/D
Placas base	2	1/21	G/D
Patas	2	1/21	G/D
Tapones	2	1/21	G/D
Platinas	2	1/21	G/D

**FRL**

Serie	Categoría	Zona	Gas/Polvo
MC#	2	1/21	G/D
N	2	1/21	G/D
MX#	2	1/21	G/D
T	2	1/21	G/D
CLR	2	1/21	G/D
M	2	1/21	G/D
MD#	2	1/21	G/D

**Valvole**

Serie	Categoría	Zona	Gas/Polvo
9#*	2	1/21	G/D
A#	2	1/21	G/D
2	2	1/21	G/D
3#	2	1/21	G/D
4#	2	1/21	G/D
NA (NAMUR) #	2	1/21	G/D
E (neumáticas)	2	1/21	G/D

\* Según Norma ISO  
 \*\* Productos con certificación ATEX e IECEX  
 # Sin solenoide

>> El orden como se forma el código para solicitar productos certificados es obtenido al añadir "EX" al código normal del producto  
 Es. 358-015 electroválvula estándar  
 Es. 358-015EX electroválvula certificada ATEX

Accesorios disponibles en categoría 2 zona 1/21: coples, uniones, soportes, tuercas, contra soportes, bujes, pernos, tapas, sellos, diafragmas, subbases, patas, válvulas manuales, reguladores de caudal, platinas, tornillos, tirantes, válvulas automáticas y bloqueadoras, silenciadores, manómetros, tornillos de ensamble, abrazaderas, racores rápidos y super-rápidos, mangueras, anillos selladores, tuercas de bloqueo. Accesorios disponibles en categoría 3, zona 2/22: adaptadores, cubiertas, extensiones, conectores. Para más información de este tipo de productos ver el sitio:  
<http://catalogue.camozzi.com> en: Descargas > Certificaciones > ATEX Directiva 2014/34/EU > Lista de productos excluidos de directiva 2014/34/EU ATEX.



# Camozzi en el mundo

## Camozzi Automation S.p.A.

Società Unipersonale  
Via Eritrea, 20/I  
25126 Brescia

### Italia

Tel. +39 030/37921  
Fax +39 030/2400464  
info@camozzi.com  
www.camozzi.com

## Camozzi Automation GmbH

Porschestraße 1  
D-73095 Albershausen

### Alemania

Tel. +49 7161/91010-0  
Fax +49 7161/91010-99  
info@camozzi.de  
www.camozzi.de

## Camozzi Neumatica S.A.

Polo Industrial Ezeiza,  
Puente del Inca 2450,  
B1812IDX, Carlos Spegazzini, Ezeiza  
Provincia de Buenos Aires

### Argentina

Tel. +54 11/52639399  
info@camozzi.com.ar  
www.camozzi.com.ar

## Camozzi Automation GmbH

Löfflerweg 18  
A-6060 Hall in Tirol

### Austria

Tel. +43 5223/52888-0  
Fax +43 5223/52888-500  
info@camozzi.at  
www.camozzi.at

## Camozzi Pneumatic

66-1, Perehodnaya str.,  
220070, Minsk

### Belarús

Tel. +375 17/3961170 (71)  
Fax +375 17/3961170 (71)  
info@camozzi.by  
www.camozzi.by

## Camozzi do Brasil Ltda.

Rod. Adauto Campo Dall'Orto, 2.200  
Condomínio Techville  
CEP 13178-440 Sumaré S.P.

### Brasil

Tel. +55 19/21374500  
sac@camozzi.com.br  
www.camozzi.com.br

## Shanghai Camozzi Automation Control Co, Ltd.

717 Shuang Dan Road, Malu  
Shanghai - 201801

### China

Tel. +86 21/59100999  
Fax +86 21/59100333  
info@camozzi.com.cn  
www.camozzi.com.cn

## Camozzi Automation ApS

Metalvej 7 F  
4000 Roskilde

### Dinamarca

Tel. +45 46/750202  
info@camozzi.dk  
www.camozzi.dk

## Camozzi Iberica SL

Avda. Altos Hornos de Vizcaya, 33, C-1  
48901 Barakaldo - Vizcaya

### España

Tel. +34 946 558 958  
info@camozzi.es  
www.camozzi.es

## Camozzi Automation, Inc.

Street address:  
2160 Redbud Boulevard, Suite 101  
McKinney, TX 75069-8252

### Remittances:

P.O. Box 678518  
Dallas, TX 75267-8518

### Estados Unidos

Tel. +1 972/5488885  
Fax +1 972/5482110  
info@camozzi-usa.com  
www.camozzi-usa.com

## Camozzi Automation OÜ

Osmussaare 8  
13811 Tallinn

### Estonia

Tel. +372 6119055  
Fax +372 6119055  
info@camozzi.ee  
www.camozzi.ee

## Camozzi Pneumatic LLC

Chasnikovo,  
Solnechnogorskiy District  
Moscow 141592

### Federación de Rusia

Tel. +7 495/786 65 85  
Fax +7 495/786 65 85  
info@camozzi.ru  
www.camozzi.ru

## Camozzi Automation Sarl

5, Rue Louis Gattefossé  
Parc de la Bandonnière  
69800 Saint-Priest

### Francia

Tel. +33 (0)478/213408  
Fax +33 (0)472/280136  
info@camozzi.fr  
www.camozzi.fr

## Camozzi India Private Limited

D-44, Hosiery Complex,  
Phase II Extension,  
Noida - 201 305  
Uttar Pradesh

### India

Tel. +91 120/4055252  
Fax +91 120/4055200  
info@camozzi-india.com  
www.camozzi.in

## Camozzi Pneumatic

### Kazakhstan LLP

Shevchenko/Radostovets,  
165b/72g, off. 615  
050009 Almaty

### Kazajstán

Tel. +7 727/3335334 - 3236250  
Fax +7 727/2377716 (17)  
info@camozzi.kz  
www.camozzi.kz

## Camozzi Malaysia SDN. BHD.

30 & 32, Jalan Industri USJ 1/3  
Taman Perindustrian USJ 1  
47600 Subang Jaya  
Selangor

### Malasia

Tel. +60 3/80238400  
Fax +60 3/80235626  
cammal@camozzi.com.my  
www.camozzi.com.my

## Camozzi Neumatica de Mexico

### S.A. de C.V.

Lago Tanganica 707  
Col. Ocho Cedros 2ª sección  
50170 Toluca

### México

Tel. +52 722/2707880 - 2126283  
Fax +52 722/2707860  
camozzi@camozzi.com.mx  
www.camozzi.com.mx

## Camozzi Automation AS

Verkstedveien 8  
1400 Ski

### Noruega

Tel. +47 40644920  
info@camozzi.no  
www.camozzi.no

## Camozzi Automation B.V.

De Vijf Boeken 1 A  
2911 BL Nieuwerkerk a/d IJssel

### Países Bajos

Tel. +31 180/316677  
info@camozzi.nl  
www.camozzi.nl

## Camozzi Automation Ltd.

The Fluid Power Centre  
Watling Street  
Nuneaton, Warwickshire  
CV11 6BQ

### Reino Unido

Tel. +44 (0)24/76374114  
Fax +44 (0)24/76347520  
info@camozzi.co.uk  
www.camozzi.co.uk

## Camozzi S.r.o.

V Chotejně 700/7  
Praha - 102 00

### República Checa

Tel. +420 272/690 994  
Fax +420 272/700 485  
info@camozzi.cz  
www.camozzi.cz

## Camozzi Automation AB

Bronsyxegatan 7  
213 75 Malmö

### Suecia

Tel. +46 40/6005800  
info@camozzi.se  
www.camozzi.se

## LLC Camozzi

Kirillovskaya Str, 1-3, section "D"  
Kiev - 04080

### Ucrania

Tel. +38 044/5369520  
Fax +38 044/5369520  
info@camozzi.ua  
www.camozzi.ua

## Camozzi Venezuela S.A.

Calle 146 con Av. 62  
N°146-180  
P.O. Box 529  
Zona Industrial Maracaibo

### Edo. Zulia

### Venezuela

Tel. +58 261/4116267  
info@camozzi.com.ve  
www.camozzi.com.ve

## Camozzi R.O.

in Hochiminh City  
6<sup>th</sup> Floor, Master Building,  
155 Hai Ba Trung St.,  
Ward 6, District 3

### Hochiminh City

### Vietnam

Tel. +84 8/54477588  
Fax +84 8/54477877  
bhthien@camozzi.com.vn  
www.camozzi.com.vn

# Distribuidores Camozzi en el mundo

## Europa

### ZULEX d.o.o.

Safeta Zajke 115b  
Sarajevo  
**Bosnia-Herzegovina**  
Tel. +387 33/776580  
Fax +387 33/776583  
zulex@bih.net.ba  
www.zulex.com.ba

### L.D. GmbH

Blvd Asen  
Yordanov 5  
1592 Sofia  
**Bulgaria**  
Tel. +359 2/9269011  
Fax +359 2/9269025  
camozzi@ld-gmbh.com  
www.ld-gmbh.com

### TS Hydropower Ltd.

Industrial Area N°64  
Aglanzia 21-03  
Nicosia  
**Chipre**  
Tel. +357 22/332085  
Fax +357 22/338608  
tshydro@cytanet.com.cy

### Bibus Zagreb d.o.o.

Anina 91  
HR 10000 Zagreb  
**Croacia**  
Tel. +385 1/3818004  
Fax +385 1/3818005  
bibus@bibus.hr  
www.bibus.hr

### STAF Automation, s.r.o.

Kostiviarska 4944/5  
974 01 Banská Bystrica  
**Eslovaquia**  
Tel. +421 48/4722777  
Fax +421 48/4722755  
staf@staf.sk  
www.staf.sk

### KOVIMEX d.o.o.

Podskrajnik 60,  
SI-1380 Cerknica  
**Eslovenia**  
Tel. +386 1/7096430  
Fax +386 1/7051930  
kovimex@kovimex.si  
www.kovimex.com

### AVS-Yhtiöt Oy

Rusthollarinkatu 8  
02270 Espoo  
**Finlandia**  
Tel. +358 10/6137100  
Fax +358 10/6137701  
info@avs-yhtiot.fi  
www.avs-yhtiot.fi

### TECHNOMATIC Group IKE

Esopou str, Kalochoi Industrial Park  
57009, Thessaloniki  
**Grecia**  
Tel. +30 2310/752773  
Fax +30 2310/778732  
info@technomaticgroup.gr  
www.technomaticgroup.gr

### Tech-Con Hungária Kft

Véső u. 9-11 (entrance: Süllő u. 8.)  
1133 Budapest  
**Hungria**  
Tel. +36 1/412 4161  
Fax +36 1/412 4171  
tech-con@tech-con.hu  
www.tech-con.hu

### Loft & Raftæki

Hjallabrekka 1  
200 Kópavogur  
**Islandia**  
Tel. +354 564/3000  
Fax +354 564/0030  
loft@loft.is  
www.loft.is

### DBF TECHNIC SIA

Bauskas iela 20 - 302  
1004 Riga  
**Letonia**  
Tel. +371 296 26916  
Fax +371 6 7808650  
info@pneimatika.lv  
www.pneimatika.lv

### Hidroteka Engineering UAB

Chemijos 29E  
LT-51333 Kaunas  
**Lituania**  
Tel. +370 37/452969  
Fax +370 37/760500  
hidroteka@hidroteka.lt  
www.hidroteka.lt

### Rayair Automation Ltd.

KW23G - Corradino Ind. Estate  
Paola, PLA3000  
**Malta**  
Tel. +356 21/672497  
Fax +356 21/805181  
sales@rayair-automation.com  
www.rayair-automation.com

### Bibus Menos Sp. z o.o.

ul. Spadochroniarzy 18  
80-298 Gdańsk  
**Polonia**  
Tel. +48 58/6609570  
Fax +48 58/6617132  
info@bibusmenos.pl  
www.bibusmenos.pl

### Experts d.o.o.

Mitropolit Teodosij Gologanov, 149  
MK-1000 Skopje  
**República De Macedonia**  
Tel. +389 2/3081970  
experts@t.mk  
www.experts.com.mk

### Tech-Con Industry S.r.l.

Calea Crângasi N°60  
Sector 6, 060346 Bucharest  
**Rumania**  
Tel. +40 21/2219640  
Fax +40 21/2219766  
automatizari@tech-congroup.com  
www.tech-con.ro

### Tech-Con d.o.o. Beograd

Cara Dušana 205a  
11080 Zemun - Belgrade  
**Serbia**  
Tel. +381 11/4142790  
Fax +381 11/3166760  
office.belgrade@tech-congroup.com  
www.tech-con.rs

### BIBUS AG

Allmendstrasse 26  
CH-8320 Fehraltorf  
**Suiza**  
Tel. +41 44/8775011  
Fax +41 44/8775019  
info.bag@bibus.ch  
www.bibus.ch

### Hidrel Hidrolik Elemanlar San. Ve Tic. A.Ş.

Percemli Sok. No:7 Tunel Mevkii  
34420 Karakoy Istanbul  
**Turquia**  
Tel. +90 212 251 73 18 - 249 48 81  
Fax +90 212 292 08 50  
info@hidrel.com.tr  
www.hidrel.com.tr

>>

# Distribuidores Camozzi en el mundo

## América

**LEVCorp S.A.**  
Av. Roma No. 7447  
Zona Obrajes  
La Paz  
**Bolivia**  
Tel. +591 2 2815658  
Fax +591 2 2815695  
info@levcorp.bo  
www.levcorp.bo

**NOMADA Ltda**  
Panamericana Norte 2998 unidad 3036  
Rencá - Santiago  
**Chile**  
Tel. +56 2 2904 0032  
ventas@nomadachile.com  
www.nomadachile.com

**Eurotécnica de Costa Rica AYM, S.A.**  
150 m oeste del cruce de Llorente,  
hacia Epa Tibás  
**Costa Rica**  
Tel. +506 2241/4242 - 4230  
Fax +506 2241/4272  
eurotecnica@eurotecnicacr.com  
www.eurotecnicacr.com

**Fluidica Cia. Ltda.**  
Abelardo Moncayo 0e4-08 y Av. América  
170509 Quito, Pichincha

**Ecuador**  
Tel. +593 2/2440848 - 2/5102004 -  
2/2254773  
Fax +593 2/2440848  
info@fluidica-ec.com  
www.fluidica-ec.com

**Aplitec S.A. de C.V.**  
75 Av. Nte,  
Residencial Escalon Norte II  
Pje Kl #3-C  
San Salvador  
**El Salvador**  
Tel. +503 2557/2666  
Fax +503 2557/2652  
info@aplitecsv.com  
www.aplitecsv.com

**Isotex de Panamá, S.A.**  
Plaza El Conquistador, Local #45  
Vía Tocúmen, Panamá City  
**Panamá**  
Tel. +507 217-0050  
Fax +507 217-0049  
info@isotexpty.com

**Eicepak S.A.C.**  
Av. Los Cipreses N° 484 Los Ficus  
Santa Anita - Lima  
**Perú**  
Tel. +51 1/3628484 - 3627127  
- 3628698  
ventas1@eicepak.com  
www.eicepak.com

**LT Industrial, SRL**  
Ave. Charles Summer #53, suite 24B  
Plaza Charles Summer  
Santo Domingo, Los Prados  
**República Dominicana**  
Tel. +1809-623-5156  
Fax +1829-956-7205  
info@ltindustrialrd.com

**Cocles S.A.**  
BVAR Artigas 4543 P.O. Box 11800  
Montevideo  
**Uruguay**  
Telefax +598 22030307/22006428/  
22090446  
cocles@adinet.com.uy  
www.cocles.com.uy

## Medio Oriente

**Al-Hawaiya for Industrial Solutions Co.**  
(ALHA)  
Kilo - 3, Makkah Road  
P.O. Box 11429  
Jeddah 21453  
**Arabia Saudita**  
Tel. +966 12/6576874  
Fax +966 12/6885061  
info@alha.com.sa  
www.alha.com.sa

**Compressed Air Technology Co.Saa**  
Cairo-Alexandria Desert Road Kilo 28  
Behind Gas Station Emirates  
Abu Rawash  
**Egipto**  
Tel. +20 35391986/35391987/35391985  
Fax +20 35391990  
neveen@elhaggarmisr.com  
info@elhaggarmisr.com  
www.elhaggarmisr.com

**I.M.O.**  
**Industrial Machine Trd. Co. L.L.C.**  
P.O. Box 20376  
Sharjah  
**Emiratos Árabes Unidos**  
Tel. +971 6/5437991 - 6/5437992  
Fax +971 6/5437994  
imo@eim.ae

**Automation Yeruham & Co.**  
34, Hahofer st.  
PO Box 1844 Length 5811702 Holon  
**Israel**  
Tel. +972 73/2606401  
Fax +972 3/5596616  
office@ayeruham.com  
www.ayeruham.com

**Raymond Feghali Co.**  
**For Trade & Industry SARL**  
Roumieh industrial zone - Lebanon  
P.O. BOX 90-723 Jdeideh  
**Libano**  
Tel. +961 1/893176 - 3/660287  
Fax +961 1/879500  
info@raymondfehalico.com  
www.raymondfehalico.com

**Al-Maram National Co. For Buildings**  
**General Contracting W.L.L.**  
Shuwaikh Industrial Area Pl. Shop No. 9  
Shuwaikh  
**Kuwait**  
Tel./Fax +965 24828108  
Cell. +965 65615386  
almaramkuwait@gmail.com  
www.almaramgmc.com

**Techno-Line Trading & Services WLL**  
Ware House 05, Building 2189  
Road 1529, Block 115  
Hidd  
**Reino de Baréin**  
Tel. +973 17783906  
Fax +973 17786906  
techline@batelco.com.bh  
sales@technoline.me

## Asia

**Taewon-AP**  
Geomdanbuk-ro 40-gil, Buk-gu  
Daegu 41511  
**Corea del Sur**  
Tel. +82 53 384 1058  
Fax +82 53 384 1057  
info@taewon-ap.com  
www.taewon-ap.com

**Korea Flutech Co. Ltd**  
No15-4, 101-gil Palgong-ro, Dong-gu,  
Daegu, 41005  
**Corea del Sur**  
Tel. +82 53 213 9090  
Fax +82 53 353 5997  
info@kflutech.com  
www.kflutech.com

**Exceltec Automation Inc.**  
608-G, EL-AL Building,  
Quezon Avenue, Tatalon  
Quezon City, 1113  
**Filipinas**  
Tel. +632/4161143 - 4161141  
- 731 9015  
Fax +632/7121672  
sales.manila@exltec.com

**PT. Golden Archy Sakti**  
Kompleks Prima Centre Blok B2 No.2  
Jl.Pool PPD - Pesing Poglar No.11,  
Kedaung Kali Angke - Cengkareng,  
Jakarta Barat 11710  
**Indonesia**  
Tel. +62 21/54377888  
Fax +62 21/54377089  
sales@archy.co.id  
www.archy.co.id

**Seika Corporation**  
Aqua Dojima East Bldg.  
16F, 4-4, 1-Chome, Dojimahama,  
Kita-Ku Osaka  
**Japón**  
Tel. +81 6/63453175  
Fax +81 6/63443584  
konof@jp.seika.com

**Polytechnic Automation**  
Suite 604, 6th Floor, K. S.  
Trade Tower,  
New Challi,  
Shahrah-e-Liaquat,  
Karachi - 74000,  
**Pakistan**  
Tel. +9221 32426612  
Fax +9221 32426188  
polytech\_ent@yahoo.com

**Exceltec Enviro Pte Ltd**  
Block 3025 Ubi Road 3  
# 03-141  
408653  
**Singapur**  
Tel. +65/67436083  
Fax +65/67439286  
sales@exltec.com

**Savikma Automation & Engineering Services (Pvt) Ltd.**

22, Wattedgedara Road  
Maharagama

**Sri Lanka**

Tel. +94 115642164  
Hot line +94 777800070  
Fax +94 112844777  
saes@slt.net.lk

**Pneumax Co. Ltd.**

107/1 Chaloen Phrakiat R.9 Rd.,  
Pravet - Bangkok 10250

**Tailandia**

Tel. +66 2/7268000  
Fax +66 2/7268260  
import@pneumax.co.th  
www.pneumax.co.th

**Zenith Automation International Co., Ltd.**

1F., No.9, Aly. 1, Ln. 5,  
Sec. 3, Ren'ai Rd.,  
Da'an Dist., Taipei City 10651

**Taiwán**

Tel. +886 2/2781 1267  
Fax +886 2/3322 8973  
zaisales@z-auto.com.tw  
www.z-auto.com.tw

## África

**Boudissa Technology Sarl**

25, Cité 20 Août 1955  
Oued Roumane El Achour  
Algeri - 16403

**Argelia**

Tel./Fax +213 (0) 23316751  
Tel./Fax +213 (0) 23316733  
contact@boudissatech.com  
www.boudissatech.com

**DISMATEC**

**Distribution de Materiels Techniques**

N° RCCM-CI-ABJ-2010B1882  
16 BP 236 ABIDJAN 16

**Costa de Marfil**

Tel. +225 21267091  
Fax +225 21262367  
dismatec2002@yahoo.fr

**Hydramatics Control Equipment**

15 Village Crescent,  
Linbro Business Park,  
Sandton Johannesburg 2065

**Sudáfrica**

Tel. +2711/6081340 - 1 - 2  
Fax +2786/5516311  
sales@hydramatics.co.za  
www.hydramatics.co.za

**A.T.C. Automatisme**

Avenue Habib Bourguiba  
Centra Said - BP 25 2033  
Megrine

**Túnez**

Tel. +216 71/297328  
Fax +216 71/429084  
commercial@atc-automatisme.com  
www.atc-automatisme.com

## Oceania

**Griffiths Components Pty Ltd**

605 Burwood Hwy  
Knoxfield Victoria  
Melbourne 3180

**Australia**

Tel. +61 3/9800 6500  
Fax +61 3/9801 8553  
enquiry@camozzi.com.au

## Contacto

### **Camozzi Iberica SL**

Avda. Altos Hornos de Vizcaya, 33, C-1  
48901 Barakaldo - Vizcaya  
España  
Tel. +34 946 558 958  
info@camozzi.es  
www.camozzi.es



Automation

A Camozzi Group Company  
**www.camozzi.com**

